

KEMET, SSRH7HS-M, Commercial Grade, 0.0185 H

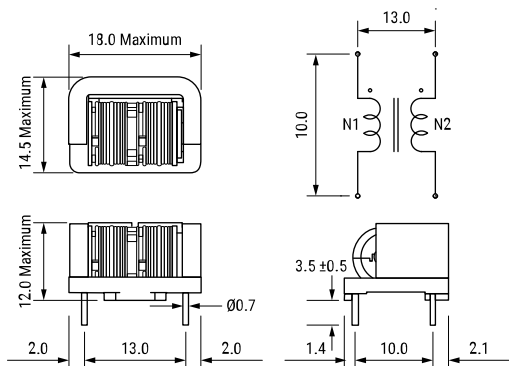

**Dimensions**

<b>L</b>	18mm MAX
<b>T</b>	14.5mm MAX
<b>H</b>	12mm MAX
<b>S</b>	10mm NOM
<b>S1</b>	13mm NOM
<b>LL</b>	3.5mm +/-0.5mm
<b>F</b>	0.7mm NOM

**Packaging Specifications**

<b>Weight:</b>	5.1 g
<b>Packaging:</b>	Bulk
<b>Packaging Quantity:</b>	600

**General Information**

<b>Series:</b>	SSRH7HS-M
<b>Style:</b>	Through-Hole Choke
<b>Description:</b>	Common Mode Filter, SSRH Coils, SSRH7HS-M Wide Range Impedance Type
<b>RoHS:</b>	Yes
<b>Miscellaneous:</b>	Temperature Rise Maximum: 50 K
<b>Notes:</b>	M06 Lot No.

**Specifications**

<b>Inductance:</b>	18.5 mH (10 kHz)
<b>Temperature Range:</b>	-25/+120C
<b>Rated Temperature:</b>	120C
<b>Current:</b>	0.6 Amps
<b>Voltage AC:</b>	250 VAC
<b>Withstanding Voltage:</b>	2400 VDC