

## Features

- Push switch option standard
- Compact, rugged design
- High reliability
- Metal bushing/shaft
- Surface mount version



# PEC11S Series - 12 mm SMD Incremental Encoder

## Electrical Characteristics

Output .....	2-bit quadrature code
Closed Circuit Resistance .....	3 ohms maximum
Contact Rating .....	10 mA @ 5 VDC
Insulation Resistance .....	100 megohms @ 250 VDC
Dielectric Withstanding Voltage	
Sea Level .....	300 VAC minimum
Electrical Travel .....	Continuous
Contact Bounce (15 RPM) .....	2.0 ms maximum
RPM (Operating) .....	60 maximum

## Environmental Characteristics

Operating Temperature Range .....	-40 °C to +70 °C (-40 °F to +158 °F)
Storage Temperature Range .....	-40 °C to +85 °C (-40 °F to +185 °F)
Operating Humidity .....	25 % to 85 % R.H.
Rotational Life .....	15,000 cycles minimum
Switch Life .....	20,000 cycles minimum
IP Rating .....	IP 40

## Mechanical Characteristics

Mechanical Angle .....	360 ° continuous
Detent Torque .....	100 ±70 gf.cm (1.36 ±0.1 oz.-in.)
Shaft Push-Pull Strength .....	10 kg max.
Weight .....	5 gm (0.17 oz.) maximum
Terminals .....	Printed circuit board surface mount terminals
Soldering Condition	
Reflow Soldering .....	Sn95.5/Ag2.8/Cu0.7 solder with no-clean flux (see Solder Profiles for recommended time and temperature)
Hand Soldering .....	Not recommended
Hardware .....	No hardware supplied with this encoder

## Switch Characteristics

Switch Type .....	Contact Push ON Momentary SPST
Power Rating (Resistive Load) .....	10 mA at 5 V DC
Switch Travel	
S (Standard) .....	0.5 ± 0.3 mm
H (High) .....	1.5 ± 0.5 mm
Switch Actuation Force .....	See How to Order
Contact Resistance .....	100 mΩ max.

## How To Order

**PEC11S - 9 2 20 F - S 0015**

Model .....	PEC11S
Terminal Configuration .....	9 = Surface Mount Gull-wing Style
Detent Option .....	2 = 30 Detents
Shaft Length (see Product Dimensions - Shaft Styles for availability) .....	20 = 20.0 mm
9 = 9.5 mm	
13 = 13.5 mm (Knurled Shaft with "H" Switch Option Only)	
15 = 15.0 mm	
Shaft Style .....	F = Flatted, Metal
K = Knurled, Metal	
Switch Configuration (SPST) .....	S = 350 ± 100 gf
H = 400 ± 200 gf	
N = No Switch	
Resolution .....	0015 = 15 Pulses per 360 ° Rotation

## Quadrature Output Table

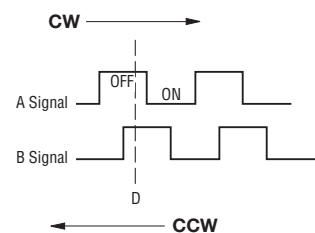

## Switch Circuit

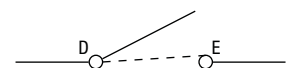

NOTE: D and E are dummy terminals on non-switch version.

\*RoHS Directive 2002/95/EC Jan. 27, 2003 including annex and RoHS Recast 2011/65/EU June 8, 2011.

Specifications are subject to change without notice.

The device characteristics and parameters in this data sheet can and do vary in different applications and actual device performance may vary over time.

Users should verify actual device performance in their specific applications.

# Applications

Level control, tuning and timer settings in:

- Audio-visual equipment
- Consumer electric appliances
- Radios
- Musical instrumentation
- Communications equipment

## PEC11S Series - 12 mm SMD Incremental Encoder BOURNS®

### Solder Profile

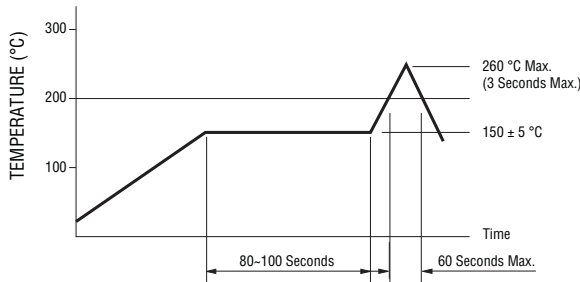

#### Notes:

1. No clean solder paste is recommended.
2. Aqueous wash is not recommended.
3. Use of water soluble soldering flux shall be avoided due to possible corrosion.
4. Multiple passes through the soldering process is not recommended.

Processing Method: Reflow soldering with infrared heat or forced air convection (only once).

### Product Dimensions

#### Common Dimensions

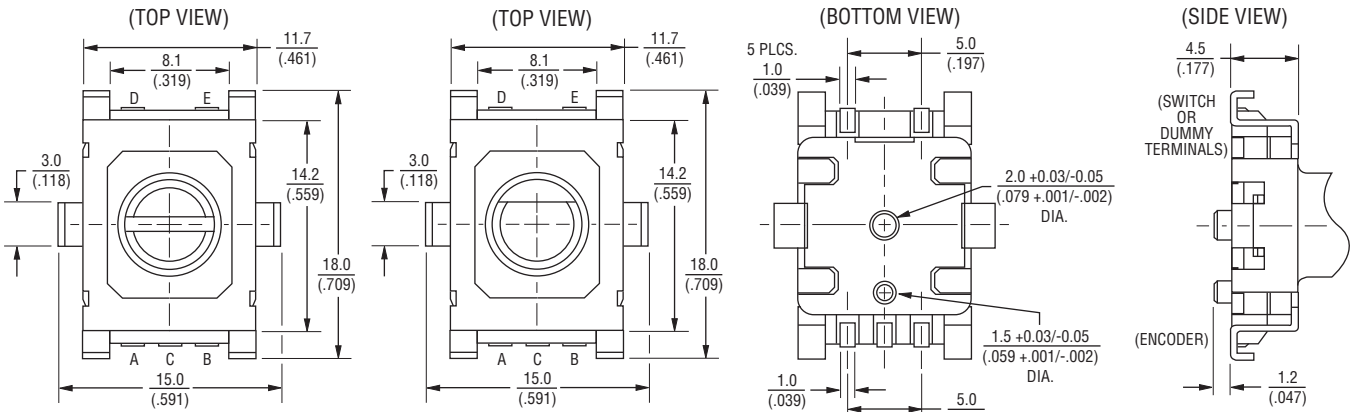

TOLERANCES (UNLESS OTHERWISE NOTED):  $\frac{\leq 10}{\leq (.394)} = \frac{\pm 0.3}{\pm (.012)}$        $\frac{> 10}{> (.394)} = \frac{\pm 0.5}{\pm (.020)}$

### Recommended PCB Layout

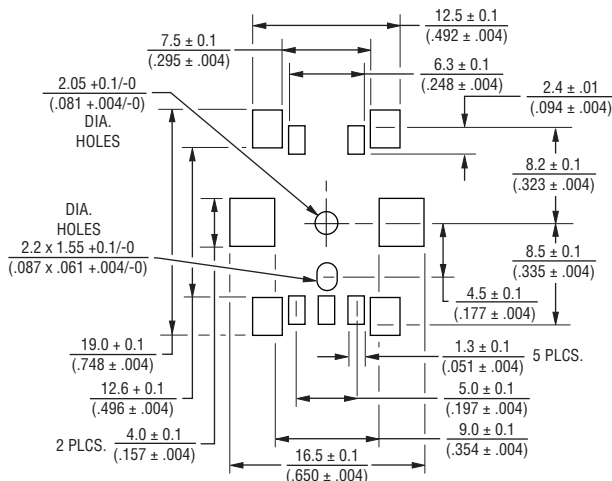

DIMENSIONS:  $\frac{\text{MM}}{\text{(INCHES)}}$

Specifications are subject to change without notice.  
The device characteristics and parameters in this data sheet can and do vary in different applications and actual device performance may vary over time.  
Users should verify actual device performance in their specific applications.

# PEC11S Series - 12 mm SMD Incremental Encoder



## Product Dimensions - Shaft Styles

### PEC11S without Switch

KNURLED SHAFT

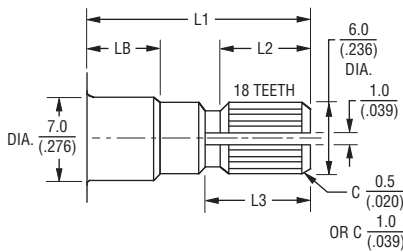

L1	LB	L2	L3
15 (.591)	5 (.197)	8 (.315)	7 (.276)
20 (.787)	7 (.276)	10 (.394)	11 (.433)

DIMENSIONS:  $\frac{\text{MM}}{\text{(INCHES)}}$

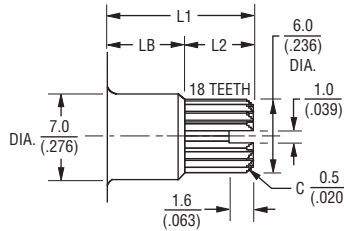

L1	LB	L2
9.5 (.374)	5 (.197)	4.5 (.177)

FLATTED SHAFT

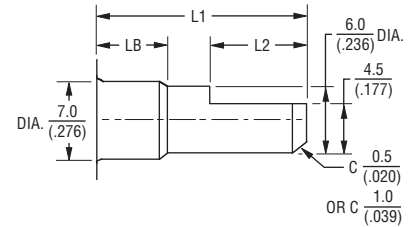

L1	LB	L2
15 (.591)	5 (.197)	7 (.276)
20 (.787)	7 (.276)	12 (.472)

### PEC11S with 0.5 mm Switch Travel

KNURLED SHAFT

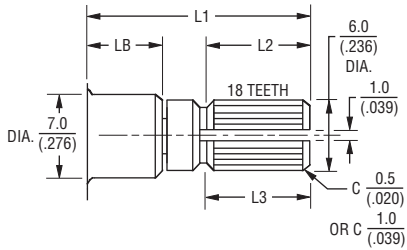

L1	LB	L2	L3
15 (.591)	5 (.197)	7 (.276)	9 (.354)
20 (.787)	7 (.276)	9 (.354)	10 (.394)

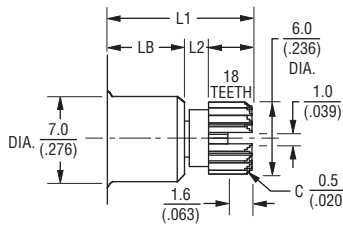

L1	LB	L2
9.5 (.374)	5 (.197)	2.9 (.114)
13.5 (.531)	5 (.197)	6.9 (.272)

FLATTED SHAFT

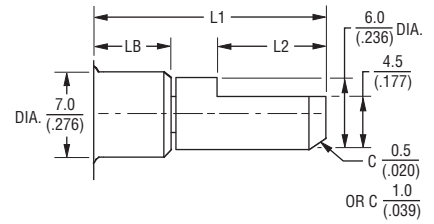

L1	LB	L2
9.5 (.374)	5 (.197)	3 (.118)
15 (.591)	5 (.197)	7 (.276)
20 (.787)	7 (.276)	10 (.394)

### PEC11S with 1.5 mm Switch Travel

KNURLED SHAFT

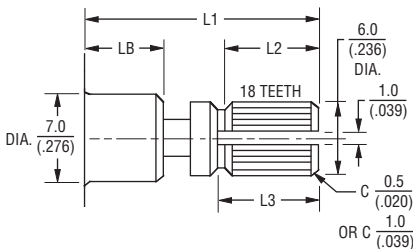

L1	LB	L2	L3
15 (.591)	5 (.197)	6 (.236)	6.5 (.256)
20 (.787)	7 (.276)	8 (.315)	9 (.354)

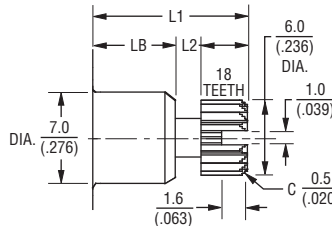

L1	LB	L2
9.5 (.374)	5 (.197)	2.9 (.114)
13.5 (.531)	5 (.197)	6.9 (.272)

FLATTED SHAFT

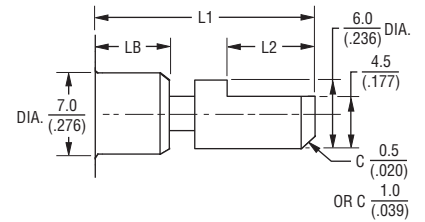

L1	LB	L2
15 (.591)	5 (.197)	7 (.276)
20 (.787)	7 (.276)	10 (.394)

REV. 03/13

Specifications are subject to change without notice.

The device characteristics and parameters in this data sheet can and do vary in different applications and actual device performance may vary over time.

Users should verify actual device performance in their specific applications.