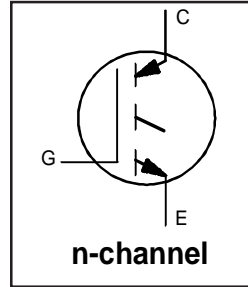


**Features**

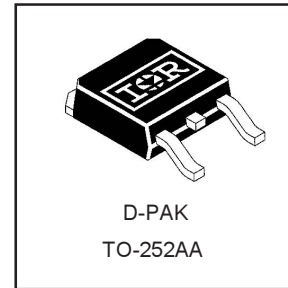
- Short Circuit Rated UltraFast: Optimized for high operating frequencies >5.0 kHz , and Short Circuit Rated to 10μs @ 125°C, V<sub>GE</sub> = 15V
- Generation 4 IGBT design provides higher efficiency than Generation 3
- Industry standard TO-252AA package
- Lead-Free



|                              |
|------------------------------|
| $V_{CES} = 600V$             |
| $V_{CE(on) typ.} = 2.39V$    |
| @ $V_{GE} = 15V, I_C = 5.0A$ |

**Benefits**

- Generation 4 IGBT's offer highest efficiency available
- IGBT's optimized for specified application conditions



**Absolute Maximum Ratings**

|                           | Parameter                              | Max.                               | Units |
|---------------------------|--|------------------------------------|-------|
| $V_{CES}$                 | Collector-to-Emitter Breakdown Voltage | 600                                | V     |
| $I_C @ T_C = 25^\circ C$  | Continuous Collector Current           | 9.0                                | A     |
| $I_C @ T_C = 100^\circ C$ | Continuous Collector Current           | 5.0                                |       |
| $I_{CM}$                  | Pulsed Collector Current ①             | 18                                 |       |
| $I_{LM}$                  | Clamped Inductive Load Current ②       | 18                                 |       |
| $t_{sc}$                  | Short Circuit Withstand Time           | 10                                 | μs    |
| $V_{GE}$                  | Gate-to-Emitter Voltage                | ± 20                               | V     |
| $E_{ARV}$                 | Reverse Voltage Avalanche Energy ③     | 34                                 | mJ    |
| $P_D @ T_C = 25^\circ C$  | Maximum Power Dissipation              | 38                                 | W     |
| $P_D @ T_C = 100^\circ C$ | Maximum Power Dissipation              | 15                                 |       |
| $T_J$                     | Operating Junction and                 | -55 to + 150                       | °C    |
| $T_{STG}$                 | Storage Temperature Range              |                                    |       |
|                           | Soldering Temperature, for 10 seconds  | 300 (0.063 in. (1.6mm) from case ) |       |

**Thermal Resistance**

|                 | Parameter                        | Typ.       | Max. | Units  |
|-----------------|----------------------------------|------------|------|--------|
| $R_{\theta JC}$ | Junction-to-Case                 | —          | 3.3  | °C/W   |
| $R_{\theta JA}$ | Junction-to-Ambient (PCB mount)* | —          | 50   |        |
| Wt              | Weight                           | 0.3 (0.01) | —    | g (oz) |

\* When mounted on 1" square PCB (FR-4 or G-10 Material).

For recommended footprint and soldering techniques refer to application note #AN-994

# IRG4RC10KPbF

## Electrical Characteristics @ $T_J = 25^\circ\text{C}$ (unless otherwise specified)

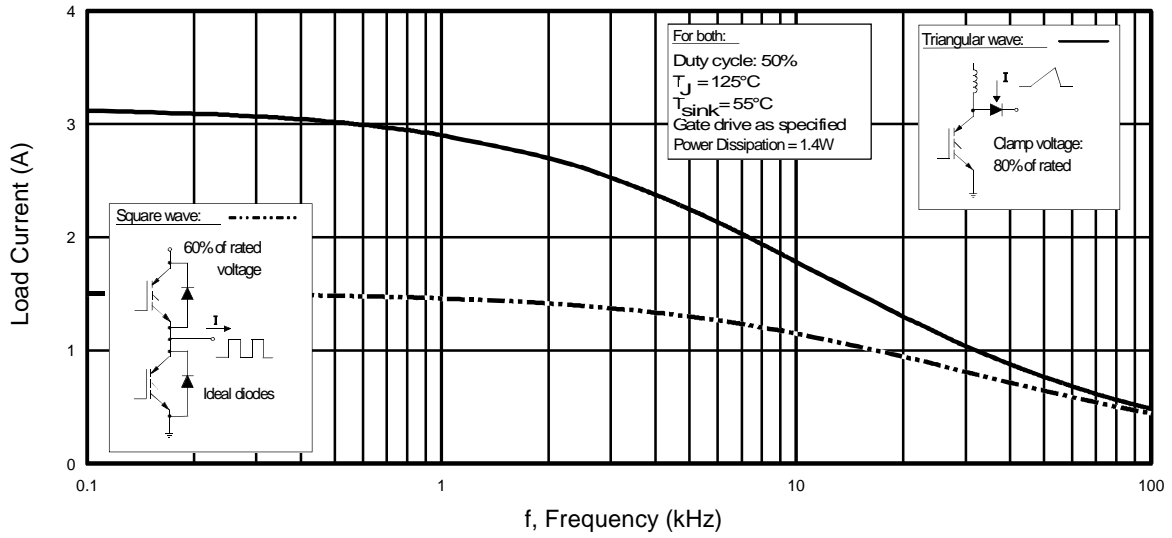
|                                 | Parameter                                | Min. | Typ. | Max.      | Units                | Conditions  |
|---------------------------------|--|------|------|-----------|----------------------|---|
| $V_{(BR)CES}$                   | Collector-to-Emitter Breakdown Voltage   | 600  | —    | —         | V                    | $V_{GE} = 0V, I_C = 250\mu A$                         |
| $V_{(BR)ECS}$                   | Emitter-to-Collector Breakdown Voltage ① | 18   | —    | —         | V                    | $V_{GE} = 0V, I_C = 1.0A$                             |
| $\Delta V_{(BR)CES}/\Delta T_J$ | Temperature Coeff. of Breakdown Voltage  | —    | 0.58 | —         | V/ $^\circ\text{C}$  | $V_{GE} = 0V, I_C = 1.0mA$                            |
| $V_{CE(ON)}$                    | Collector-to-Emitter Saturation Voltage  | —    | 2.39 | 2.62      | V                    | $I_C = 5.0A$<br>$V_{GE} = 15V$<br>See Fig.2, 5        |
|                                 |  | —    | 3.25 | —         |                      |   |
|                                 |  | —    | 2.63 | —         |                      |   |
| $V_{GE(th)}$                    | Gate Threshold Voltage                   | 3.0  | —    | 6.5       |                      | $V_{CE} = V_{GE}, I_C = 250\mu A$                     |
| $\Delta V_{GE(th)}/\Delta T_J$  | Temperature Coeff. of Threshold Voltage  | —    | -11  | —         | mV/ $^\circ\text{C}$ | $V_{CE} = V_{GE}, I_C = 250\mu A$                     |
| $g_{fe}$                        | Forward Transconductance ②               | 1.2  | 1.8  | —         | S                    | $V_{CE} = 50V, I_C = 5.0A$                            |
| $I_{CES}$                       | Zero Gate Voltage Collector Current      | —    | —    | 250       | $\mu A$              | $V_{GE} = 0V, V_{CE} = 600V$                          |
|                                 |  | —    | —    | 2.0       |                      | $V_{GE} = 0V, V_{CE} = 10V, T_J = 25^\circ\text{C}$   |
|                                 |  | —    | —    | 1000      |                      | $V_{GE} = 0V, V_{CE} = 600V, T_J = 150^\circ\text{C}$ |
| $I_{GES}$                       | Gate-to-Emitter Leakage Current          | —    | —    | $\pm 100$ | nA                   | $V_{GE} = \pm 20V$                                    |

## Switching Characteristics @ $T_J = 25^\circ\text{C}$ (unless otherwise specified)

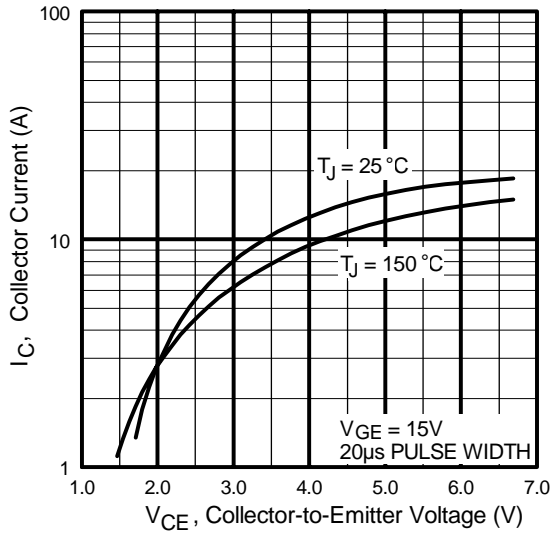
|              | Parameter                         | Min. | Typ. | Max. | Units   | Conditions   |
|--------------|-----------------------------------|------|------|------|---------|--|
| $Q_g$        | Total Gate Charge (turn-on)       | —    | 19   | 29   | nC      | $I_C = 5.0A$<br>$V_{CC} = 400V$<br>$V_{GE} = 15V$<br>See Fig.8   |
| $Q_{ge}$     | Gate - Emitter Charge (turn-on)   | —    | 2.9  | 4.3  |         |  |
| $Q_{gc}$     | Gate - Collector Charge (turn-on) | —    | 9.8  | 15   |         |  |
| $t_{d(on)}$  | Turn-On Delay Time                | —    | 11   | —    | ns      | $T_J = 25^\circ\text{C}$<br>$I_C = 5.0A, V_{CC} = 480V$<br>$V_{GE} = 15V, R_G = 100\Omega$<br>Energy losses include "tail"<br>See Fig. 9,10,14   |
| $t_r$        | Rise Time                         | —    | 24   | —    |         |  |
| $t_{d(off)}$ | Turn-Off Delay Time               | —    | 51   | 77   |         |  |
| $t_f$        | Fall Time                         | —    | 190  | 290  |         |  |
| $E_{on}$     | Turn-On Switching Loss            | —    | 0.16 | —    |         |  |
| $E_{off}$    | Turn-Off Switching Loss           | —    | 0.10 | —    | mJ      | See Fig. 9,10,14   |
| $E_{ts}$     | Total Switching Loss              | —    | 0.26 | 0.32 |         |  |
| $t_{sc}$     | Short Circuit Withstand Time      | 10   | —    | —    | $\mu s$ | $V_{CC} = 400V, T_J = 125^\circ\text{C}$<br>$V_{GE} = 15V, R_G = 100\Omega, V_{CPK} < 500V$  |
| $t_{d(on)}$  | Turn-On Delay Time                | —    | 11   | —    | ns      | $T_J = 150^\circ\text{C}$<br>$I_C = 5.0A, V_{CC} = 480V$<br>$V_{GE} = 15V, R_G = 100\Omega$<br>Energy losses include "tail"<br>See Fig. 10,11,14 |
| $t_r$        | Rise Time                         | —    | 27   | —    |         |  |
| $t_{d(off)}$ | Turn-Off Delay Time               | —    | 67   | —    |         |  |
| $t_f$        | Fall Time                         | —    | 350  | —    |         |  |
| $E_{ts}$     | Total Switching Loss              | —    | 0.47 | —    | mJ      | See Fig. 10,11,14  |
| $L_E$        | Internal Emitter Inductance       | —    | 7.5  | —    | nH      | Measured 5mm from package  |
| $C_{ies}$    | Input Capacitance                 | —    | 220  | —    | pF      | $V_{GE} = 0V$<br>$V_{CC} = 30V$<br>$f = 1.0MHz$<br>See Fig. 7  |
| $C_{oes}$    | Output Capacitance                | —    | 29   | —    |         |  |
| $C_{res}$    | Reverse Transfer Capacitance      | —    | 7.5  | —    |         |  |

### Notes:

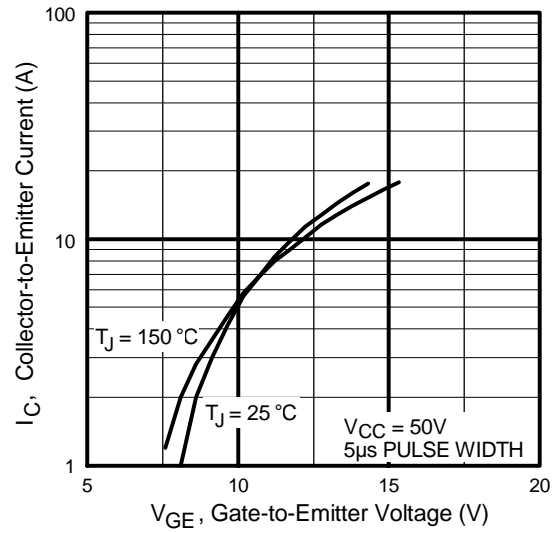
- ① Repetitive rating;  $V_{GE} = 20V$ , pulse width limited by max. junction temperature. ( See fig. 13b )
- ②  $V_{CC} = 80\%(V_{CES}), V_{GE} = 20V, L = 10\mu H, R_G = 100\Omega$ , (See fig. 13a)
- ③ Repetitive rating; pulse width limited by maximum junction temperature.
- ④ Pulse width  $\leq 80\mu s$ ; duty factor  $\leq 0.1\%$ .
- ⑤ Pulse width  $5.0\mu s$ , single shot.



**Fig. 1** - Typical Load Current vs. Frequency  
(Load Current =  $I_{RMS}$  of fundamental)

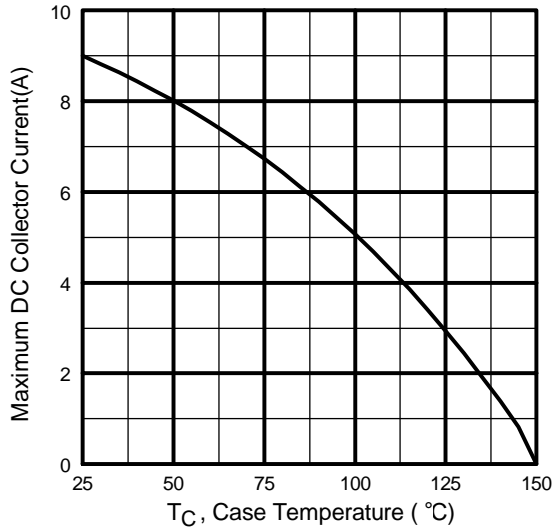


**Fig. 2** - Typical Output Characteristics

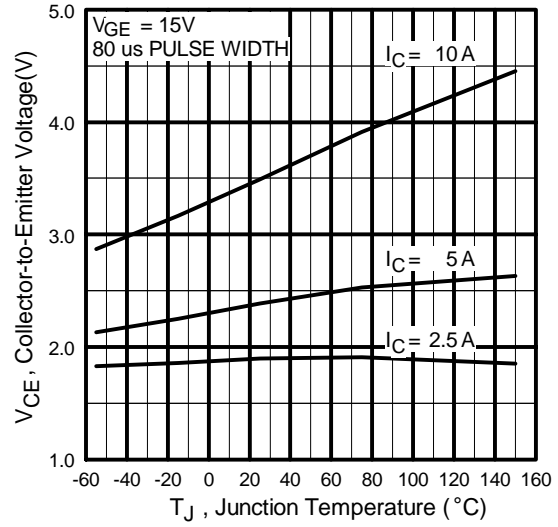


**Fig. 3** - Typical Transfer Characteristics

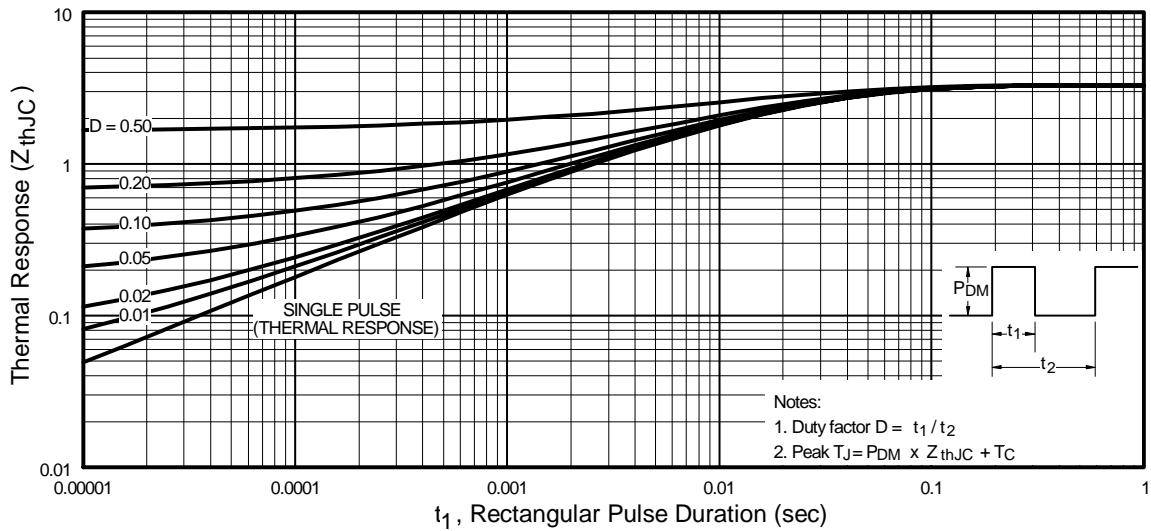
# IRG4RC10KPbF



**Fig. 4** - Maximum Collector Current vs. Case Temperature

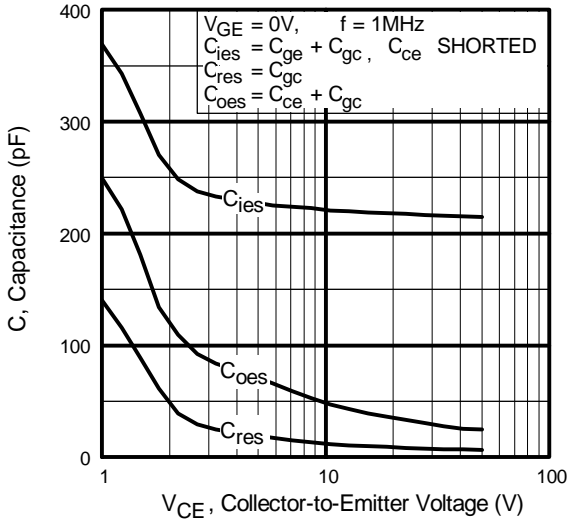


**Fig. 5** - Typical Collector-to-Emitter Voltage vs. Junction Temperature

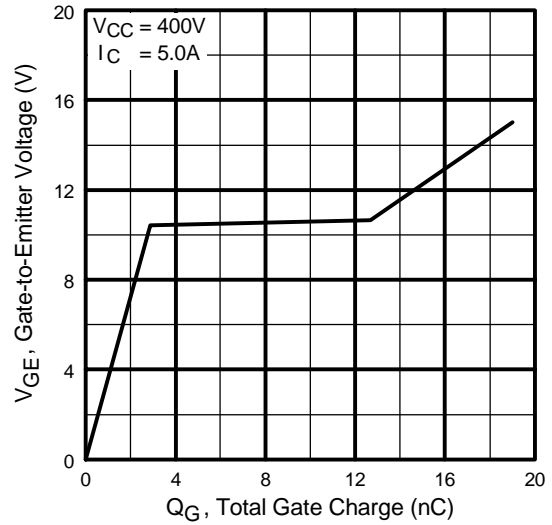


**Fig. 6** - Maximum Effective Transient Thermal Impedance, Junction-to-Case

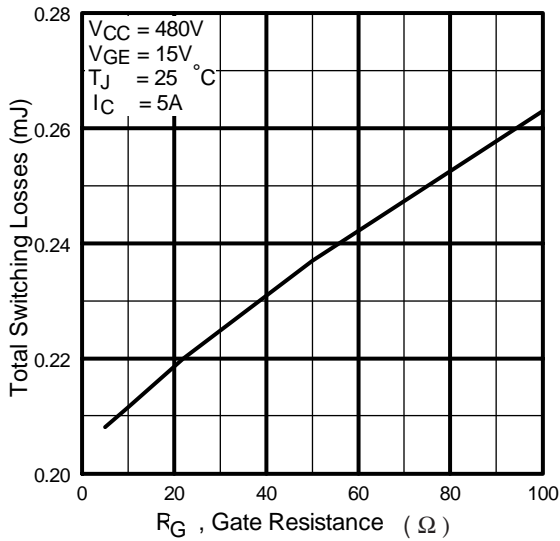
# IRG4RC10KPbF



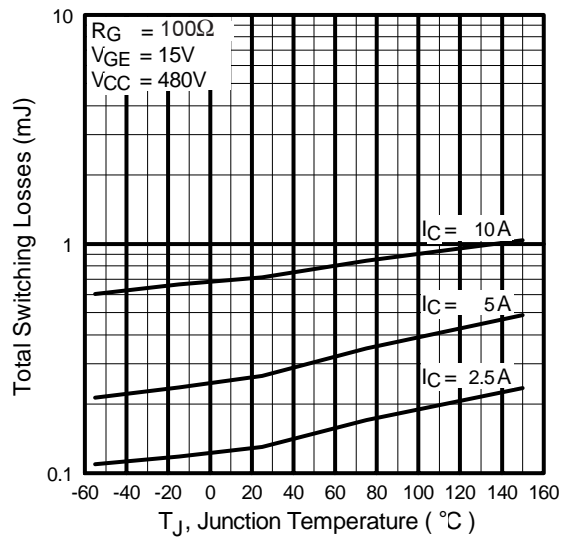
**Fig. 7** - Typical Capacitance vs. Collector-to-Emitter Voltage



**Fig. 8** - Typical Gate Charge vs. Gate-to-Emitter Voltage

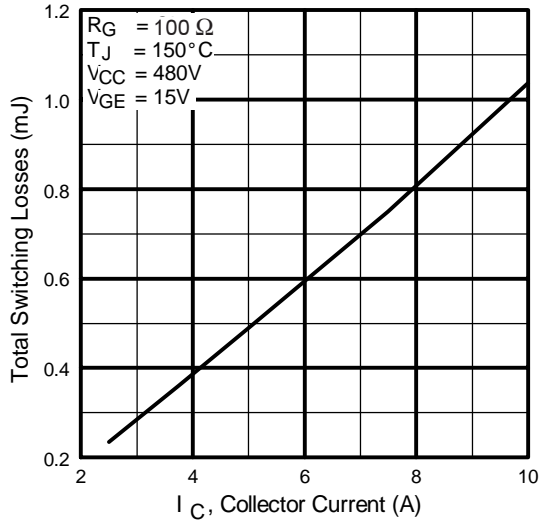


**Fig. 9** - Typical Switching Losses vs. Gate Resistance

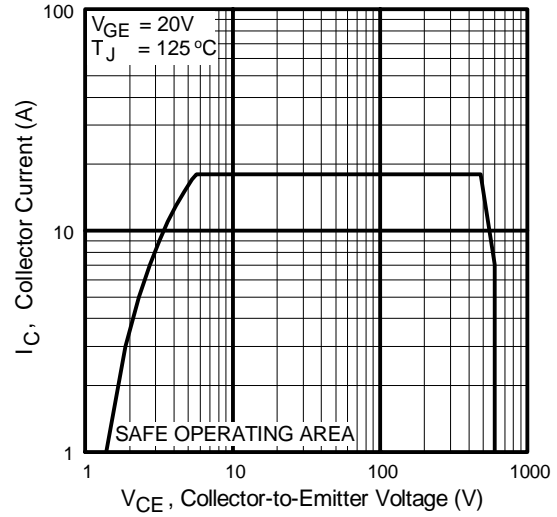


**Fig. 10** - Typical Switching Losses vs. Junction Temperature

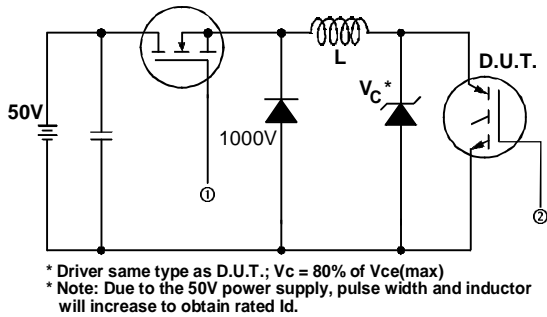
# IRG4RC10KPbF



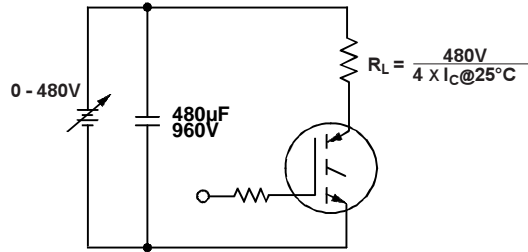
**Fig. 11** - Typical Switching Losses vs. Collector Current



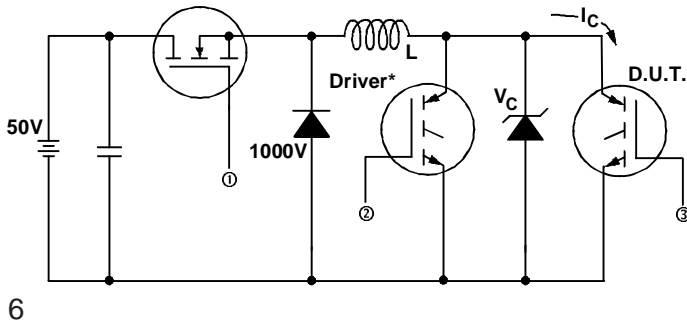
**Fig. 12** - Turn-Off SOA



**Fig. 13a** - Clamped Inductive Load Test Circuit

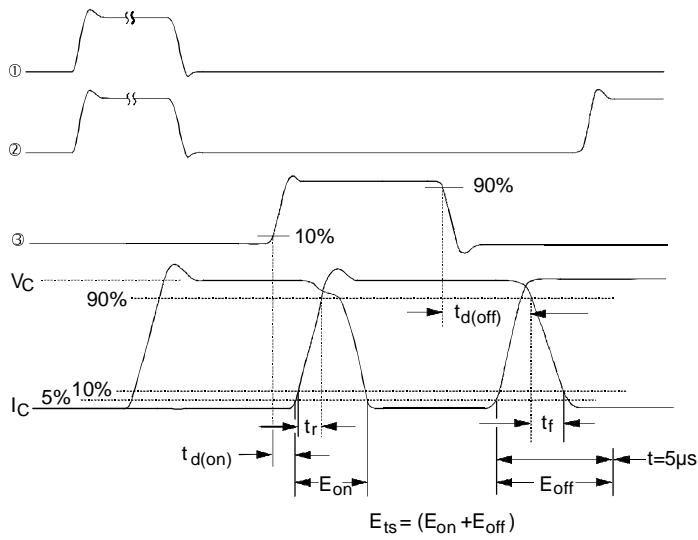


**Fig. 13b** - Pulsed Collector Current Test Circuit



**Fig. 14a** - Switching Loss Test Circuit

\* Driver same type as D.U.T.,  $V_C = 480\text{V}$

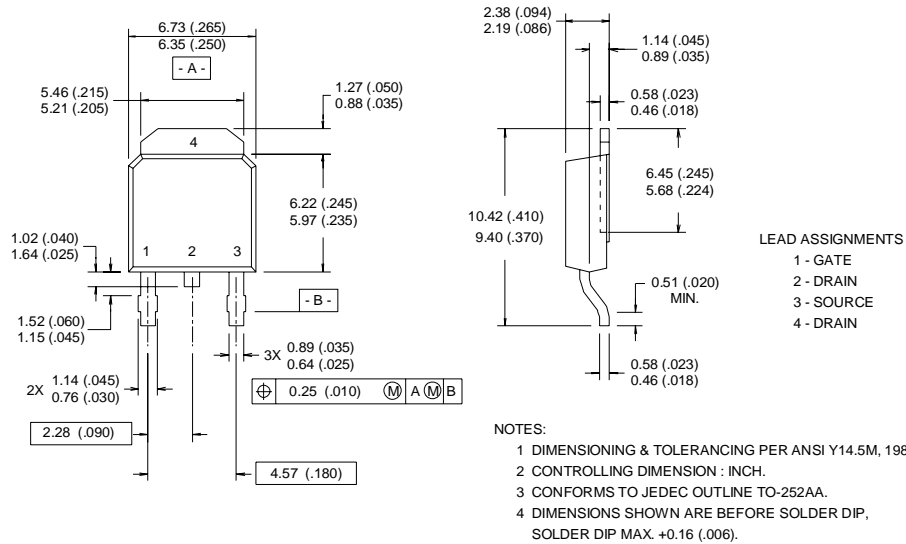


**Fig. 14b** - Switching Loss Waveforms

# IRG4RC10Kpbf

## D-Pak (TO-252AA) Package Outline

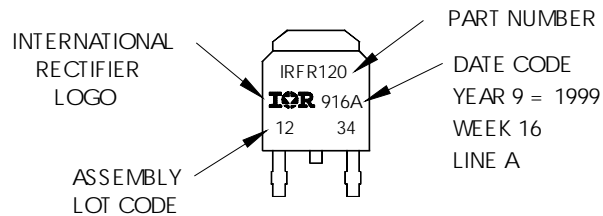
Dimensions are shown in millimeters (inches)



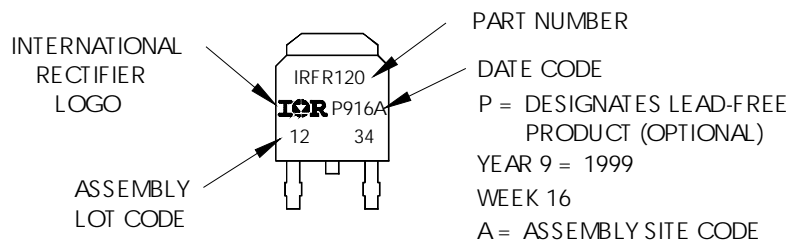
## D-Pak (TO-252AA) Part Marking Information

EXAMPLE: THIS IS AN IRFR120  
 WITH ASSEMBLY  
 LOT CODE 1234  
 ASSEMBLED ON WW 16, 1999  
 IN THE ASSEMBLY LINE "A"

Note: "P" in assembly line  
 position indicates "Lead-Free"



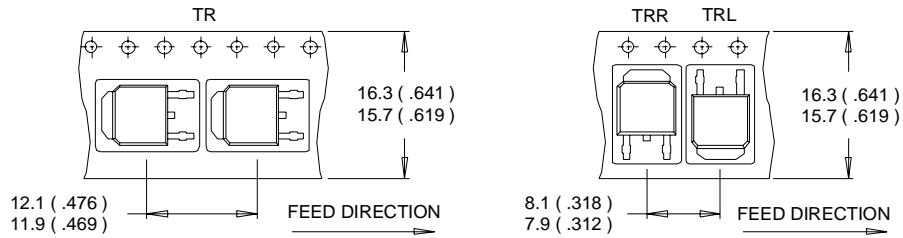
## OR





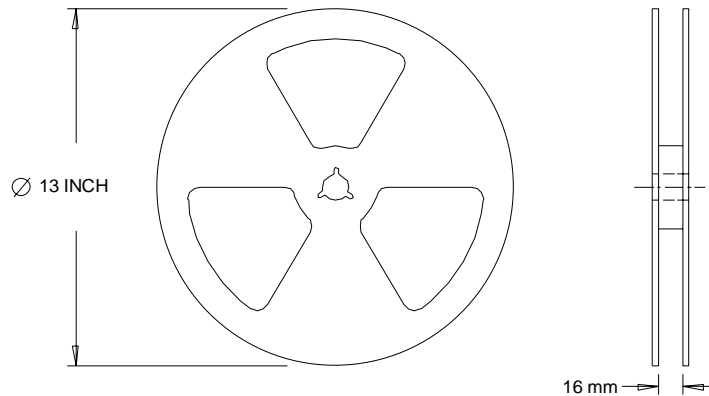
## D-Pak (TO-252AA) Tape & Reel Information

Dimensions are shown in millimeters (inches)



NOTES :

1. CONTROLLING DIMENSION : MILLIMETER.
2. ALL DIMENSIONS ARE SHOWN IN MILLIMETERS ( INCHES ).
3. OUTLINE CONFORMS TO EIA-481 & EIA-541.



NOTES :

1. OUTLINE CONFORMS TO EIA-481.

Data and specifications subject to change without notice.

Note: For the most current drawings please refer to the IR website at:  
<http://www.irf.com/package/>