

LOC	DIST	REVISIONS					
E	B	P	LTR	DESCRIPTION	DATE	DWN	APVD
			BB	NEW RELEASE	19JULY2010	PT	St.P

FOR FURTHER INFORMATION SEE DATA SHEET FOR
RN73 SERIES-HIGH PRECISION RESISTORS (SMD)

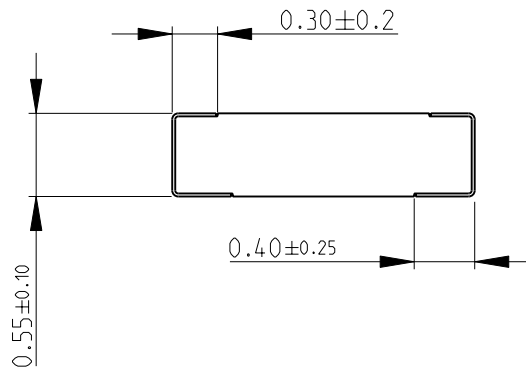

RECOMMENDED LAND PATTERN

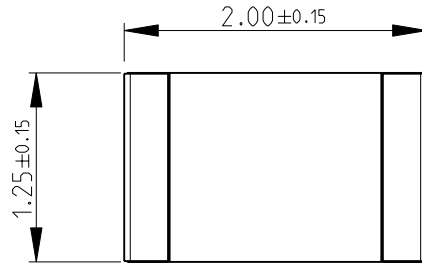
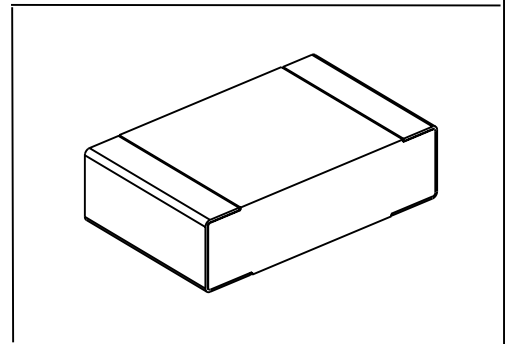
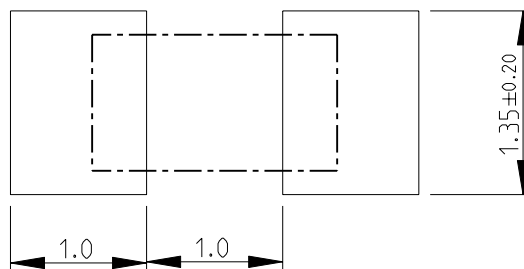

2010

RELEASED FOR PUBLICATION

BY TYCO ELECTRONICS CORPORATION. ALL RIGHTS RESERVED.

© COPYRIGHT 2010

THIS DRAWING IS UNPUBLISHED.

DIMENSIONS: mm	DWN PARUSURAM.T	19JULY2010	MATERIAL	-	FINISH	-
	CHK ALLAN.P	19JULY2010	Tyco Electronics Corporation Dorcan, Swindon, SN3 5HH			
TOLERANCES UNLESS OTHERWISE SPECIFIED:	APVD STEPHEN.P	19JULY2010				
0 PLC ±0.2	PRODUCT SPEC	-	NAME HIGH PRECISION RESISTORS (SMD) SERIES RN73 2A			
1 PLC ±0.1	APPLICATION SPEC	-				
2 PLC ±-	WEIGHT	-	SIZE	A 4	CAGE CODE	00779
3 PLC ±-			DRAWING NO	C= 1614741		RESTRICTED TO
4 PLC ±-						-
ANGLES ±5°						
	CUSTOMER DRAWING		SCALE	20:1	SHEET	1 OF 1
						REV BB