

P	LTR	DESCRIPTION	DATE	DWN	APVD
	B4	REVISED	28OCT13	AY	TH

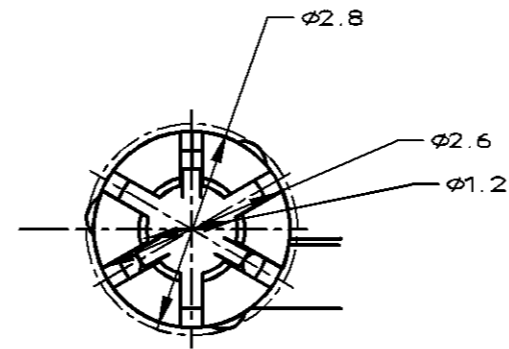

D-D
SCALE 20:1

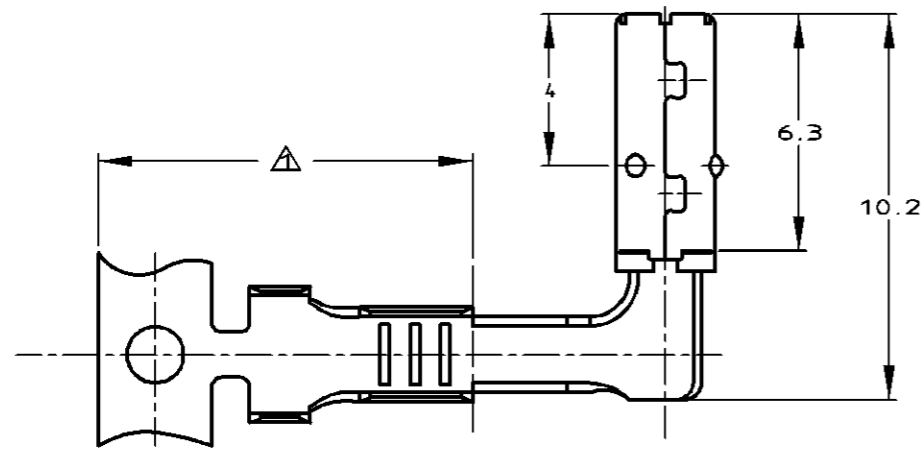
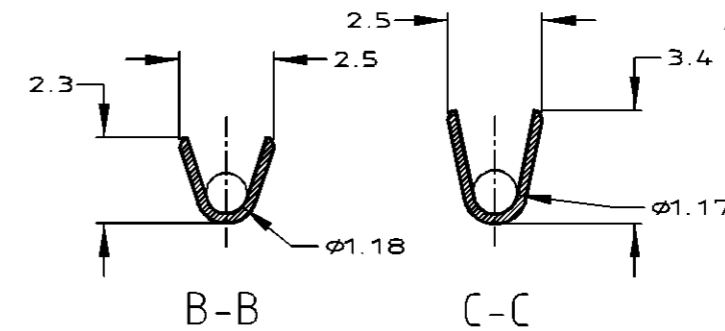

-3:AS SHOWN
-3:本図

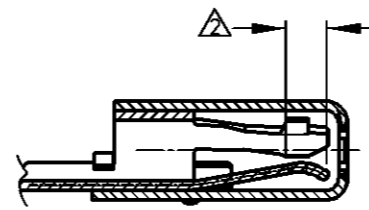
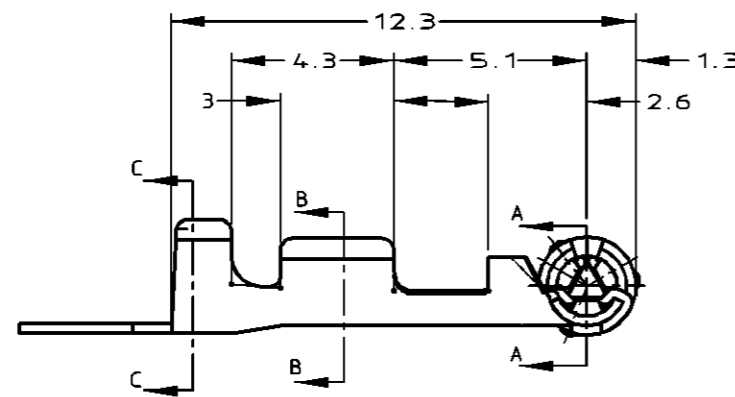

A-A

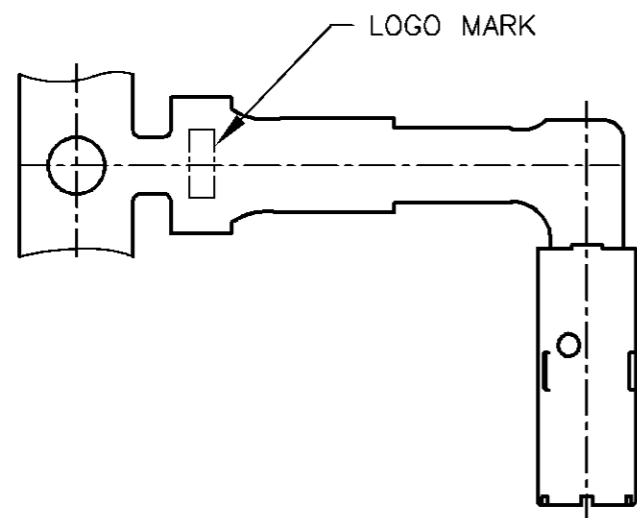
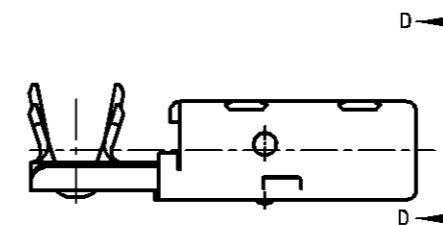

- △ すべてめっき範囲
- △ 部分めっき範囲
- 3. 適用電線は取付適用規格を参照のこと
- 4. 本製品の圧着作業については、以下の規格取説を参照すること
- 取付適用規格 : 114-5234
- 取扱説明書 : 411-5785

- △ TIN PLATING AREA
- △ GOLD PLATING AREA
- 3 APPLICABLE WIRE:SEE APPLICATION SPEC
- 4 MUST BE REFERRED TO THE FOLLOWING DOCUMENTS FOR CLIPPING OPERATION
- APPLICATION SPEC.: 114-5234
- INSTRUCTION SHEET : 411-5785

353376-3
PART NUMBER

TOLERANCES UNLESS OTHERWISE SPECIFIED:
一般公差

10 ≥	: ±0.2
30 ≥	>10 : ±0.25
100 ≥	>30 : ±0.3
ANGLE : ±3°	

THIS DRAWING IS A CONTROLLED DOCUMENT.		DWN T.HIBINO 17FEB97	STE TE Connectivity			
DIMENSIONS: 単位: 耗 mm		CHK Y.OKADA 17FEB97				
TOLERANCES UNLESS OTHERWISE SPECIFIED: 一般公差		APVD A.NAGAMINE 17FEB97	NAME 名称			
0 PLC ±-		PRODUCT SPEC 製品規格	SQUIB CONTACT			
1 PLC ±-		APPLICATION SPEC 取付適用規格 114-5234				
2 PLC ±-		WEIGHT 0.38 g	SIZE A3	CAGE CODE 00779	DRAWING NO 番号 C=353376	RESTRICTED TO
3 PLC ±-		CUSTOMER DRAWING		SCALE 尺度 5:1	SHEET 1 OF 1	REV B4
4 PLC ANGLES ±-		MATERIAL 材料 Cu Alloy		FINISH 仕上 SELECTIVE GOLD		