

# CoolMOS™ 1) Power MOSFET

Electrically isolated back surface  
 2500 V electrical isolation  
 N-Channel Enhancement Mode  
 Low  $R_{DS(on)}$ , high  $V_{DSS}$  MOSFET  
 Ultra low gate charge



$$I_{D25} = 15 \text{ A}$$

$$V_{DSS} = 600 \text{ V}$$

$$R_{DS(on) \text{ max}} = 0.165 \Omega$$

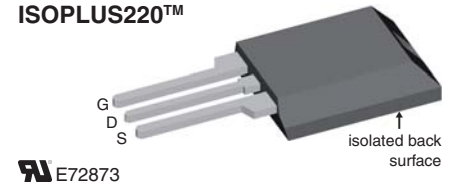
**ISOPLUS220™**

MOSFET			
Symbol	Conditions	Maximum Ratings	
$V_{DSS}$	$T_{VJ} = 25^\circ\text{C}$	600	V
$V_{GS}$		$\pm 20$	V
$I_{D25}$	$T_C = 25^\circ\text{C}$	15	A
$I_{D90}$	$T_C = 90^\circ\text{C}$	11	A
$E_{AS}$ $E_{AR}$	single pulse repetitive } $I_D = 7.9 \text{ A}; T_C = 25^\circ\text{C}$	522 0.79	mJ mJ
$dV/dt$	MOSFET $dV/dt$ ruggedness $V_{DS} = 0 \dots 480 \text{ V}$	50	V/ns

**Features**

- Silicon chip on Direct-Copper-Bond substrate
  - high power dissipation
  - isolated mounting surface
  - 2500 V electrical isolation
  - low drain to tab capacitance ( $< 30 \text{ pF}$ )
- Fast CoolMOS™ 1) power MOSFET 4<sup>th</sup> generation
  - high blocking capability
  - lowest resistance
  - avalanche rated for unclamped inductive switching (UIS)
  - low thermal resistance due to reduced chip thickness
- Enhanced total power density

Symbol	Conditions	Characteristic Values			
		$(T_{VJ} = 25^\circ\text{C}, \text{ unless otherwise specified})$			
		min.	typ.	max.	
$R_{DS(on)}$	$V_{GS} = 10 \text{ V}; I_D = 12 \text{ A}$		150	165	m $\Omega$
$V_{GS(th)}$	$V_{DS} = V_{GS}; I_D = 0.79 \text{ mA}$	2.5	3	3.5	V
$I_{DSS}$	$V_{DS} = 600 \text{ V}; V_{GS} = 0 \text{ V}$			1	$\mu\text{A}$
	$T_{VJ} = 25^\circ\text{C}$ $T_{VJ} = 125^\circ\text{C}$		10		$\mu\text{A}$
$I_{GSS}$	$V_{GS} = \pm 20 \text{ V}; V_{DS} = 0 \text{ V}$			100	nA
$C_{iss}$ $C_{oss}$	$V_{GS} = 0 \text{ V}; V_{DS} = 100 \text{ V}$ $f = 1 \text{ MHz}$		2000 100		pF pF
$Q_g$ $Q_{gs}$ $Q_{gd}$	$V_{GS} = 0 \text{ to } 10 \text{ V}; V_{DS} = 400 \text{ V}; I_D = 12 \text{ A}$		40 9 13	52	nC nC nC
$t_{d(on)}$ $t_r$ $t_{d(off)}$ $t_f$	$V_{GS} = 10 \text{ V}; V_{DS} = 400 \text{ V}$ $I_D = 12 \text{ A}; R_G = 3.3 \Omega$		12 5 50 5		ns ns ns ns
$R_{thJC}$				1.1	K/W

**Applications**

- Switched mode power supplies (SMPS)
- Uninterruptible power supplies (UPS)
- Power factor correction (PFC)
- Welding
- Inductive heating
- PDP and LCD adapter

**Advantages**

- Easy assembly: no screws or isolation foils required
- Space savings
- High power density
- High reliability

<sup>1)</sup> CoolMOS™ is a trademark of Infineon Technologies AG.

**Source-Drain Diode**

Symbol	Conditions	Characteristic Values		
		min.	typ.	max.
( $T_{VJ} = 25^{\circ}\text{C}$ , unless otherwise specified)				
$I_S$	$V_{GS} = 0\text{ V}$		12	A
$V_{SD}$	$I_F = 12\text{ A}; V_{GS} = 0\text{ V}$	0.9	1.2	V
$t_{rr}$	$I_F = 12\text{ A}; -di_F/dt = 100\text{ A}/\mu\text{s}; V_R = 400\text{ V}$	390		ns
$Q_{RM}$		7.5		$\mu\text{C}$
$I_{RM}$		38		A

**Component**

Symbol	Conditions	Maximum Ratings		
		min.	typ.	max.
$T_{VJ}$	operating	-55...+150		$^{\circ}\text{C}$
$T_{stg}$	storage	-55...+150		$^{\circ}\text{C}$
$V_{ISOL}$	RMS leads-to-tab, 50/60 Hz, $f = 1$ minute		2500	V~
$F_C$	mounting force	11-65 / 2.4-11		N/lb

Symbol	Conditions	Characteristic Values		
		min.	typ.	max.
$R_{thCH}$	with heatsink compound	0.35		K/W
Weight		2.7		g

**ISOPLUS220™ Outline**

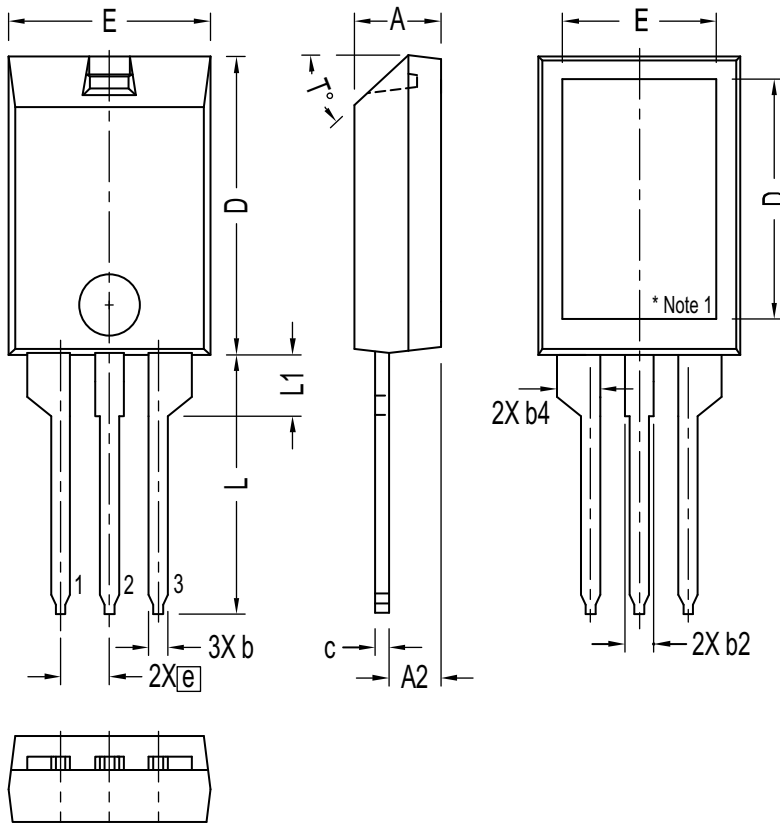
SYM	INCHES		MILLIMETERS	
	MIN	MAX	MIN	MAX
A	.157	.197	4.00	5.00
A2	.098	.118	2.50	3.00
b	.035	.051	0.90	1.30
b2	.049	.065	1.25	1.65
b4	.093	.100	2.35	2.55
c	.028	.039	0.70	1.00
D	.591	.630	15.00	16.00
D1	.472	.512	12.00	13.00
E	.394	.433	10.00	11.00
E1	.295	.335	7.50	8.50
e	.100 BASIC		2.55 BASIC	
L	.512	.571	13.00	14.50
L1	.118	.138	3.00	3.50
T°			42.5°	47.5°

**NOTE:**

1. Bottom heatsink is electrically isolated from Pin 1, 2, or 3.
2. This drawing will meet dimensional requirement of JEDEC SS Product Outline TO-273 except D and D1 dimension.

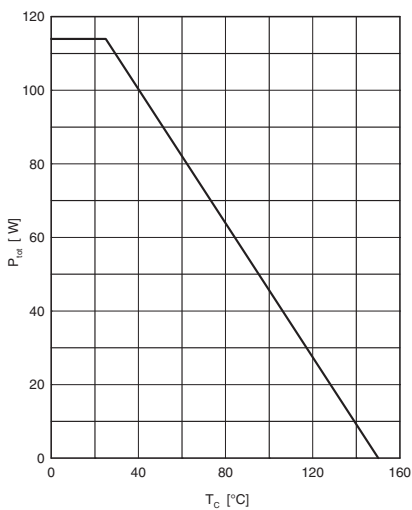

Fig. 1 Power dissipation

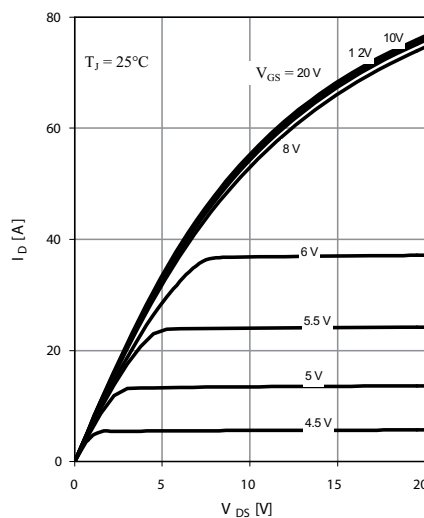

Fig. 2 Typ. output characteristics

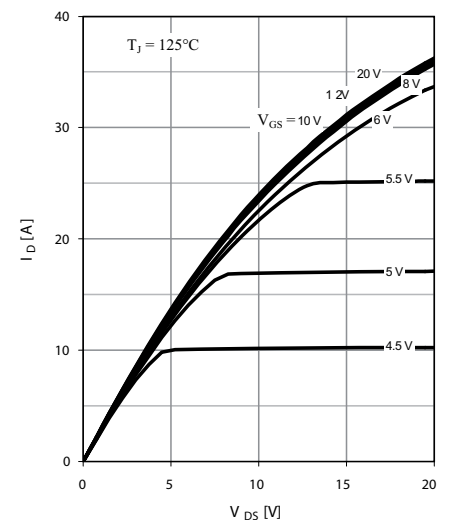

Fig. 3 Typ. output characteristics

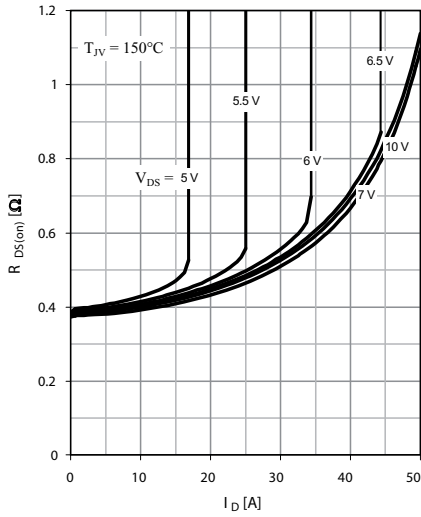

Fig. 4 Typ. drain-source on-state resistance

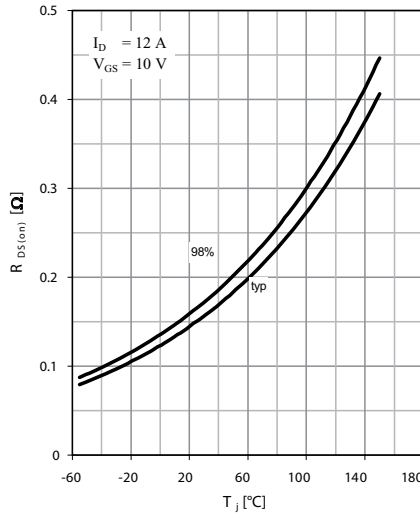

Fig. 5 Drain-source on-state resistance

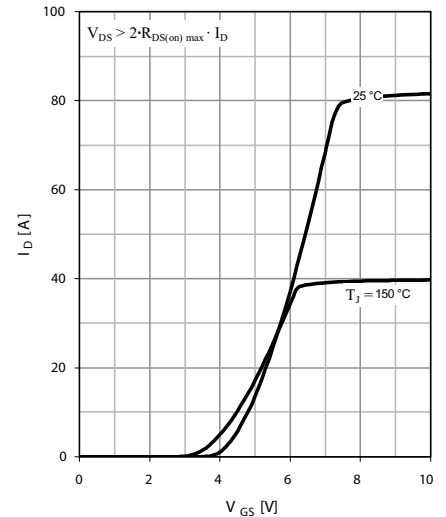

Fig. 6 Typ. transfer characteristics

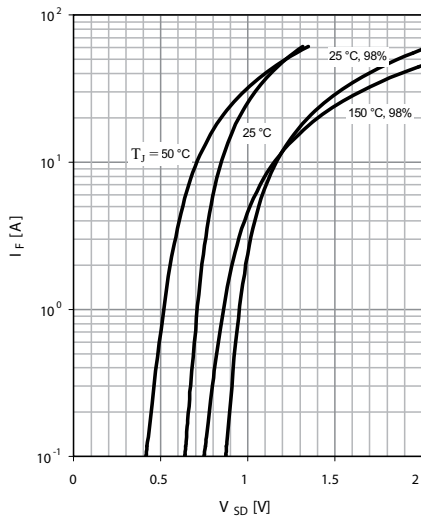

Fig. 7 Forward characteristic of reverse diode

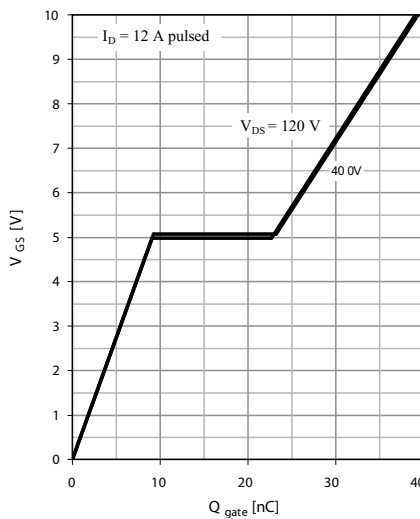

Fig. 8 Typ. gate charge

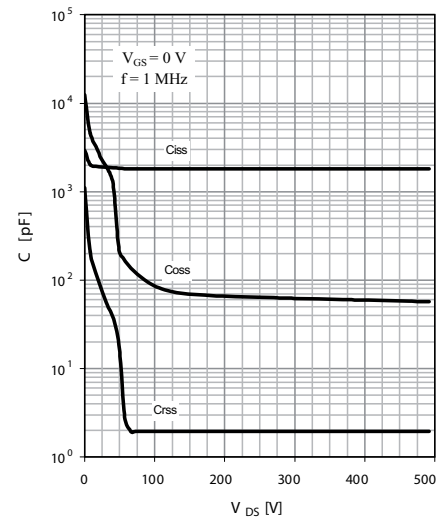

Fig. 9 Typ. capacitances

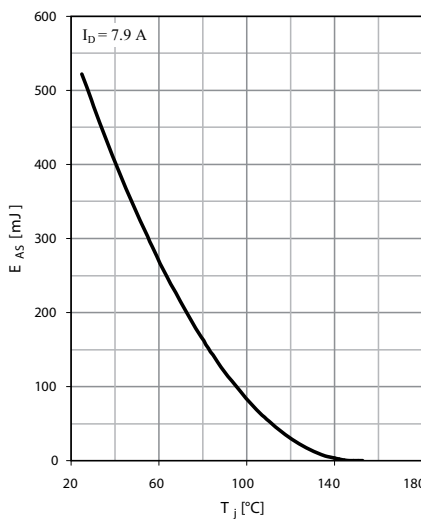

Fig. 10 Avalanche energy

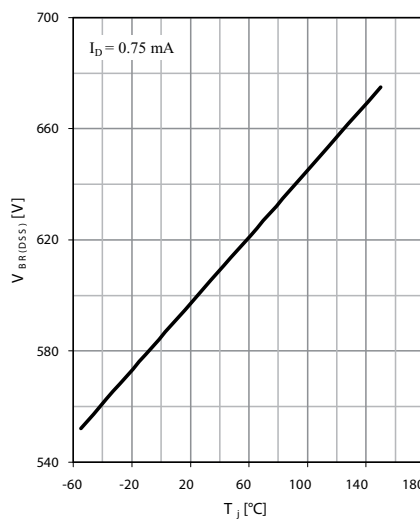

Fig. 11 Drain-source breakdown voltage

IXYS reserves the right to change limits, test conditions and dimensions.

20090209b