

REVISIONS					
REV	ECD	DESCRIPTION	DATE	BY	APPR
01	-	RELEASE NEW DWG FORMAT	-	-	-

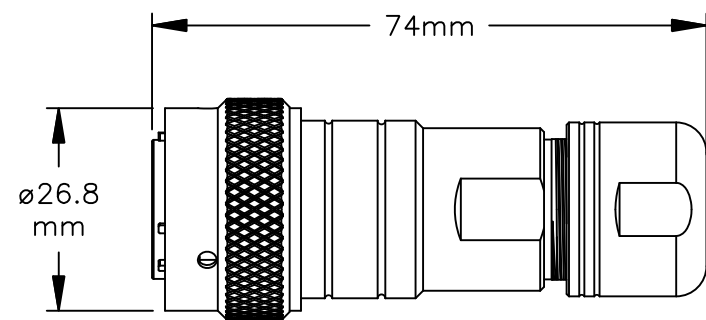

ASSEMBLED VIEW

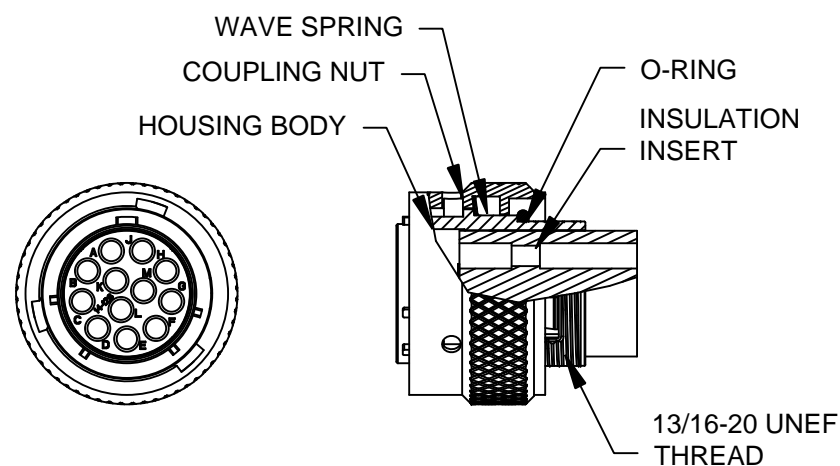
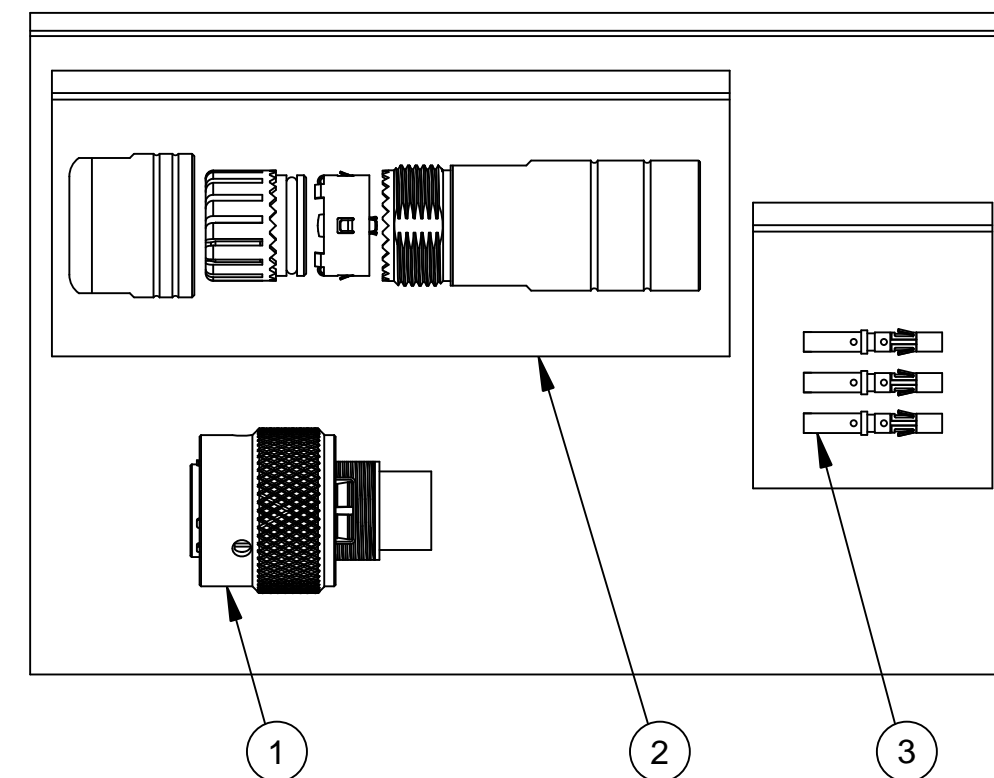

ILLUSTRATION: COMPLETE KIT



NOTES:

- 1) CORD GRIP RANGE: 3mm TO 6.5mm
- 2) CONTACT BARREL RANGE: 16AWG TO 18AWG
- 3) RECOMMENDED CRIMP TOOLS:
HAND CRIMPER: MFX-3959
PNEUMATIC CRIMPER: MFX-3960
- 4) EXTRACTION TOOL: QXRT16
- 5) MATERIALS:
HOUSING BODY: ZINC DIE CAST, NICKEL PLATED
COUPLING NUT: ALUMINUM ALLOY, NICKEL PLATED
WAVE SPRING: STAINLESS STEEL
INSULATION INSERT: PA66, UL94/V-0
CONTACT: BRASS, GOLD FLASH PLATED
SEAL AND O-RING: NBR (NITRILE BUTADIENE RUBBER)
- 6) ELECTRICAL DATA:
a) CURRENT (MAX): 13A
b) VOLTAGE (MAX): 250V AC/DC
c) INSULATION RESISTANCE (MIN): 5000M OHMS
d) TEST VOLTAGE (BETWEEN CONTACTS): 3050V

7) TECHNICAL DATA:

- a) TEMPERATURE RANGE: -40°C TO 105°C
- b) PROTECTION: IP67 (MATED CONDITION)
- c) MATING CYCLES: >500
- d) VIBRATION RESISTANCE PER MIL-STD-202 METHOD 204
- e) THERMAL SHOCK PER MIL-STD-202 METHOD 207
- f) 48 HOUR SALT SPRAY PER MIL-STD-202 METHOD 101

8) RoHS COMPLIANT

QUANTITY	PART NUMBER	DESCRIPTION	ITEM
12	MS16M23F	CONTACT, SOCKET, SIZE 16	3
1	RT0L-14CG-S1	CORD GRIP	2
1	RT061412SNH	CONNECTOR	1

MATERIALS LIST

UNLESS OTHERWISE SPECIFIED		SIGNATURES		DATE		<h1 style="text-align: center;">Amphenol</h1> <p style="text-align: center;">Sine Systems - www.amphenol-sine.com 44724 Morley Drive Clinton Township, MI 48036</p> <p style="text-align: center; font-weight: bold;">KIT, ECO-MATE</p>			
1) All dimensions are in metric(mm).		DRAWN: MRF		10SEP13					
2) Tolerances are as follows:		CHECKED:							
1 PL DEC ±0.30 2 PL DEC ±0.15 3 PL DEC ±0.08		ENGINEER:							
3) Note reference =		APPROVAL:				CUSTOMER:			
MATERIAL SPECIFICATIONS:		CUSTOMER:				THIS DRAWING IS SUPPLIED FOR INFORMATION ONLY. DESIGN FEATURES, SPECIFICATIONS AND PERFORMANCE DATA SHOWN HEREON ARE THE PROPERTY OF THE AMPHENOL CORPORATION. NO RIGHTS OF REPRODUCTION ARE IMPLIED. ALL DIMENSIONS ARE SUBJECT TO NORMAL MANUFACTURING VARIATIONS.			
PROCESS SPECIFICATIONS:		CUSTOMER:				SIZE	TYPE	DWG NO.	REVISION
NEXT ASSY:		CUSTOMER:				B	C-	RT061412SNH-K	01
		CUSTOMER:				SCALE: NONE		SHEET 1 OF 1	

TITLE:

KIT, ECO-MATE

DWG NO:

REV: 01

SH: 1

DF: 1