

Dimensions: [mm]

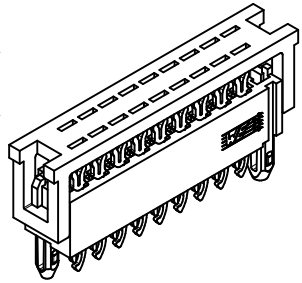

Scale - 1,5:1

Recommended PCB Layout [mm]:

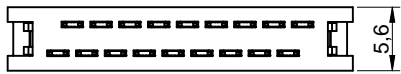
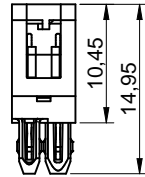
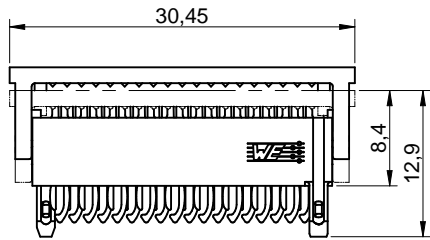
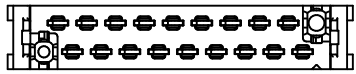
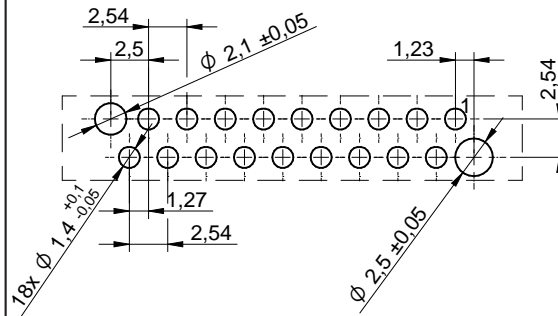

Scale - 2:1

Drillhole specification for PCB:

Drill hole specification for chemical surfaces (Ni/Au)

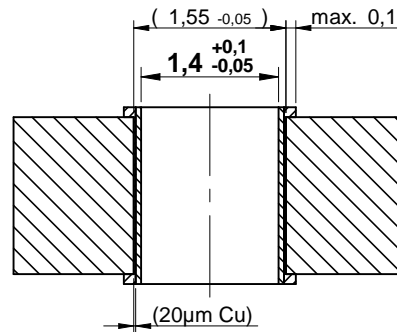

Properties:

Properties	Value	Unit	Tol.
Insulator Material	LCP		
Insulator Flammability Rating	UL94 V-0		
Insulator Color	Black		
Contact Material	CuNiSi		
Contact Plating	Au (SKEDD), Sn (IDC)		
Pitch	P	2.54	mm
Cable	AWG 28/1.27 mm ribbon cable		
Operating Temperature	-25 °C up to +105 °C		
Compliance	Lead free / RoHS		
Micro-cuts during vibration (sinusoidal)	Discontinuity ≤ 1µs Test conditions: 5g, 1h 45min/axis, 10 to 150 Hz, 20 cycles/axis, according to IEC 60068-2-6		
Mating Cycle ¹⁾	10		max.
Mating Cycle ²⁾	25		max.
PCB Thickness	1.6	mm	

¹⁾ Standard application

²⁾ Application: debugging, programming

Electrical Properties:

Properties	Test conditions	Value	Unit	Tol.
Rated Current	@ 20 °C	I _R	1	A
Working Voltage	@ 20 °C		100	V (AC)
Insulation Resistance	@ 20 °C	R _{ISO}	1000	MΩ min.
Withstanding Voltage	1 min. @ 20 °C		500	V (AC)
Contact Resistance	@ 20 °C	R	10	mΩ max.

Packaging Properties:

Packaging	Tube
-----------	------

Würth Elektronik eiSos GmbH & Co. KG
EMC & Inductive Solutions

Max-Eyth-Str. 1
74638 Waldenburg
Germany
Tel. +49 (0) 79 42 945 - 0

www.we-online.com
eiSos@we-online.com



CREATED
DaSc

CHECKED
DKü

GENERAL TOLERANCE
DIN ISO 2768-1m

PROJECTION METHOD

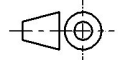

DESCRIPTION

REDFIT IDC SKEDD Connector WR-WST

ORDER CODE

490107671812

REVISION
001.001

STATUS
Valid

DATE (YYYY-MM-DD)
2017-11-13

BUSINESS UNIT
eiCan

PAGE
1/3

Cautions and warnings for REDFIT IDC SKEDD Connectors:

The following conditions apply to all REDFIT IDC SKEDD Connectors (hereinafter referred as to “electronic component”, “component” or “connector”) of Würth Elektronik eiSos GmbH & Co. KG.

General:

- This electronic component is designed and developed with the intention for use in general electronics equipment.
- Before incorporating the components into any equipment in the field such as aerospace, aviation, nuclear control, submarine, transportation, (automotive control, train control, ship control), transportation signal, disaster prevention, medical, public information network etc. where higher safety and reliability are especially required or if there is possibility of direct damage or injury to human body, Würth Elektronik must be asked for a written approval.
- In addition, even electronic component in general electronic equipment, when used in electrical circuits that require high safety, reliability functions or performance, the sufficient reliability evaluation-check for the safety must be performed by the user before usage.
- The connector is designed and manufactured to be used within the datasheet specified values.
- Do not use the connector outside the datasheet specifications.
- Prevent any damage or scratches on the connector, especially on the actuator.
- Direct mechanical impact to the product shall be prevented (e.g overlapping of the PCB's).
- The responsibility for the applicability of the customer specific products and use in a particular customer design is always within the authority of the customer. All technical specification for standard products do also apply to customer specific products.
- REDFIT IDC SKEDD Connectors are designed to be used along with Würth Elektronik counterparts and tools. Würth Elektronik cannot ensure the reliability of these components while being used with other products.

Product specific:

Cleaning and Washing:



- The connector is not constructed for washing, so washing can cause malfunction afterwards.
- Cleaning agents that are used to clean the customer applications might damage or change the characteristics of the component, body, pins and termination.
- Please do not submerge our washable products into water or cleaning agents or put them in locations exposed to water completely.
- When cleaning by hand (brushing), please do not use excessive force on our connectors to avoid malfunction afterwards, because function relevant areas might get deformed.
- We recommended a solution without organic acid (preserve the plating against corrosion) volatile, without residues and compatible with the plastic.
- We recommend to perform tests and to let a component in immersion in the solution 8 to 12 hours and see if there is a degradation.

Storage Conditions:

- REDFIT IDC SKEDD Connectors are considered MSL1 into closed original packaging and are not subject to storage time limits regarding the moisture sensitivity, but all products shall be used before the end of the period of 12 months based on the products date code.

Handling and Processing:

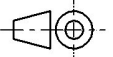
- Do not repeatedly operate the connector with excessive force. It may damage or deform the contact dome which results in malfunction.
- In case a connector requires particular handling precautions, in addition to the general recommendations mentioned here before, these will appear on the product datasheet.
- The connector is designed for the specified mating cycles, all mating cycles above the specified mating cycles are at own risk.
- It's necessary that the connector is plugged and unplugged at a 90° angle to the PCB, if not, it may cause in reduced mating cycles and/or damage the connector.
- Do not solder this connector! The Soldering Process damages the SKEDD functionality.
- It's designed only to be plugged directly into the PCB.
- The cable has to be first pressed to the IDC side, after that, it can be plugged into the PCB.
- It has to be ensured that the connector is fully plugged into the PCB, otherwise, the retention force might be reduced and the signal/power connection might be interrupted or lost.
- We recommend using the Würth Elektronik Tool 600600282800 with the insert 4900001 to press the connector.
- It's recommended to secure the Flat Ribbon Cable on the PCB or external.
- We recommend the cable to go straight ahead from the connector. If bending is necessary, be sure to bend the cable at least 20mm away from the edge of the connector. Don't bend directly at the connector's edge. Before and after bending, be sure that the connector is fixed in its place with no pressure on it.
- The Contacts have a play in the Housing, this is necessary for the functionality of the SKEDD Contacts.

Würth Elektronik eiSos GmbH & Co. KG EMC & Inductive Solutions Max-Eyth-Str. 1 74638 Waldenburg Germany Tel. +49 (0) 79 42 945 - 0 www.we-online.com eiSos@we-online.com	CREATED	CHECKED	GENERAL TOLERANCE	PROJECTION METHOD	
	DaSc	DKü	DIN ISO 2768-1m		
	DESCRIPTION			ORDER CODE	
	REFIT IDC SKEDD Connector WR-WST			490107671812	
	REVISION	STATUS	DATE (YYYY-MM-DD)	BUSINESS UNIT	PAGE
	001.001	Valid	2017-11-13	eiCan	2/3

Important Notes

The following conditions apply to all goods within the product range of Würth Elektronik eiSos GmbH & Co. KG:

1. General Customer Responsibility

Some goods within the product range of Würth Elektronik eiSos GmbH & Co. KG contain statements regarding general suitability for certain application areas. These statements about suitability are based on our knowledge and experience of typical requirements concerning the areas, serve as general guidance and cannot be estimated as binding statements about the suitability for a customer application. The responsibility for the applicability and use in a particular customer design is always solely within the authority of the customer. Due to this fact it is up to the customer to evaluate, where appropriate to investigate and decide whether the device with the specific product characteristics described in the product specification is valid and suitable for the respective customer application or not.

2. Customer Responsibility related to Specific, in particular Safety-Relevant Applications

It has to be clearly pointed out that the possibility of a malfunction of electronic components or failure before the end of the usual lifetime cannot be completely eliminated in the current state of the art, even if the products are operated within the range of the specifications. In certain customer applications requiring a very high level of safety and especially in customer applications in which the malfunction or failure of an electronic component could endanger human life or health it must be ensured by most advanced technological aid of suitable design of the customer application that no injury or damage is caused to third parties in the event of malfunction or failure of an electronic component. Therefore, customer is cautioned to verify that data sheets are current before placing orders. The current data sheets can be downloaded at www.we-online.com.

3. Best Care and Attention

Any product-specific notes, cautions and warnings must be strictly observed. Any disregard will result in the loss of warranty.

4. Customer Support for Product Specifications

Some products within the product range may contain substances which are subject to restrictions in certain jurisdictions in order to serve specific technical requirements. Necessary information is available on request. In this case the field sales engineer or the internal sales person in charge should be contacted who will be happy to support in this matter.

5. Product R&D

Due to constant product improvement product specifications may change from time to time. As a standard reporting procedure of the Product Change Notification (PCN) according to the JEDEC-Standard inform about minor and major changes. In case of further queries regarding the PCN, the field sales engineer or the internal sales person in charge should be contacted. The basic responsibility of the customer as per Section 1 and 2 remains unaffected.

6. Product Life Cycle



Due to technical progress and economical evaluation we also reserve the right to discontinue production and delivery of products. As a standard reporting procedure of the Product Termination Notification (PTN) according to the JEDEC-Standard we will inform at an early stage about inevitable product discontinuance. According to this we cannot guarantee that all products within our product range will always be available. Therefore it needs to be verified with the field sales engineer or the internal sales person in charge about the current product availability expectancy before or when the product for application design-in disposal is considered. The approach named above does not apply in the case of individual agreements deviating from the foregoing for customer-specific products.

7. Property Rights

All the rights for contractual products produced by Würth Elektronik eiSos GmbH & Co. KG on the basis of ideas, development contracts as well as models or templates that are subject to copyright, patent or commercial protection supplied to the customer will remain with Würth Elektronik eiSos GmbH & Co. KG. Würth Elektronik eiSos GmbH & Co. KG does not warrant or represent that any license, either expressed or implied, is granted under any patent right, copyright, mask work right, or other intellectual property right relating to any combination, application, or process in which Würth Elektronik eiSos GmbH & Co. KG components or services are used.

8. General Terms and Conditions

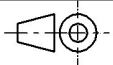
Unless otherwise agreed in individual contracts, all orders are subject to the current version of the "General Terms and Conditions of Würth Elektronik eiSos Group", last version available at www.we-online.com.

Würth Elektronik eiSos GmbH & Co. KG EMC & Inductive Solutions Max-Eyth-Str. 1 74638 Waldenburg Germany Tel. +49 (0) 79 42 945 - 0 www.we-online.com eiSos@we-online.com	CREATED DaSc	CHECKED DKü	GENERAL TOLERANCE DIN ISO 2768-1m	PROJECTION METHOD 	
	DESCRIPTION REDFIT IDC SKEDD Connector WR-WST		ORDER CODE 490107671812		
		REVISION 001.001	STATUS Valid	DATE (YYYY-MM-DD) 2017-11-13	BUSINESS UNIT eiCan