

## STRADA-2X2-T2-M

IESNA Type II Medium beam with excellent back light control, illuminance uniformity and cutoff

### TECHNICAL SPECIFICATIONS:

Dimensions	50.0 mm
Height	11.9 mm
Fastening	glue, pin, screw
Colour	clear
Box size	476 x 273 x 292 mm
Box weight	10.4 kg
Quantity in Box	800 pcs
ROHS compliant	yes ⓘ



### MATERIAL SPECIFICATIONS:

Component	Type	Material	Colour
STRADA-2X2-T2-M	Lens array	PMMA	clear

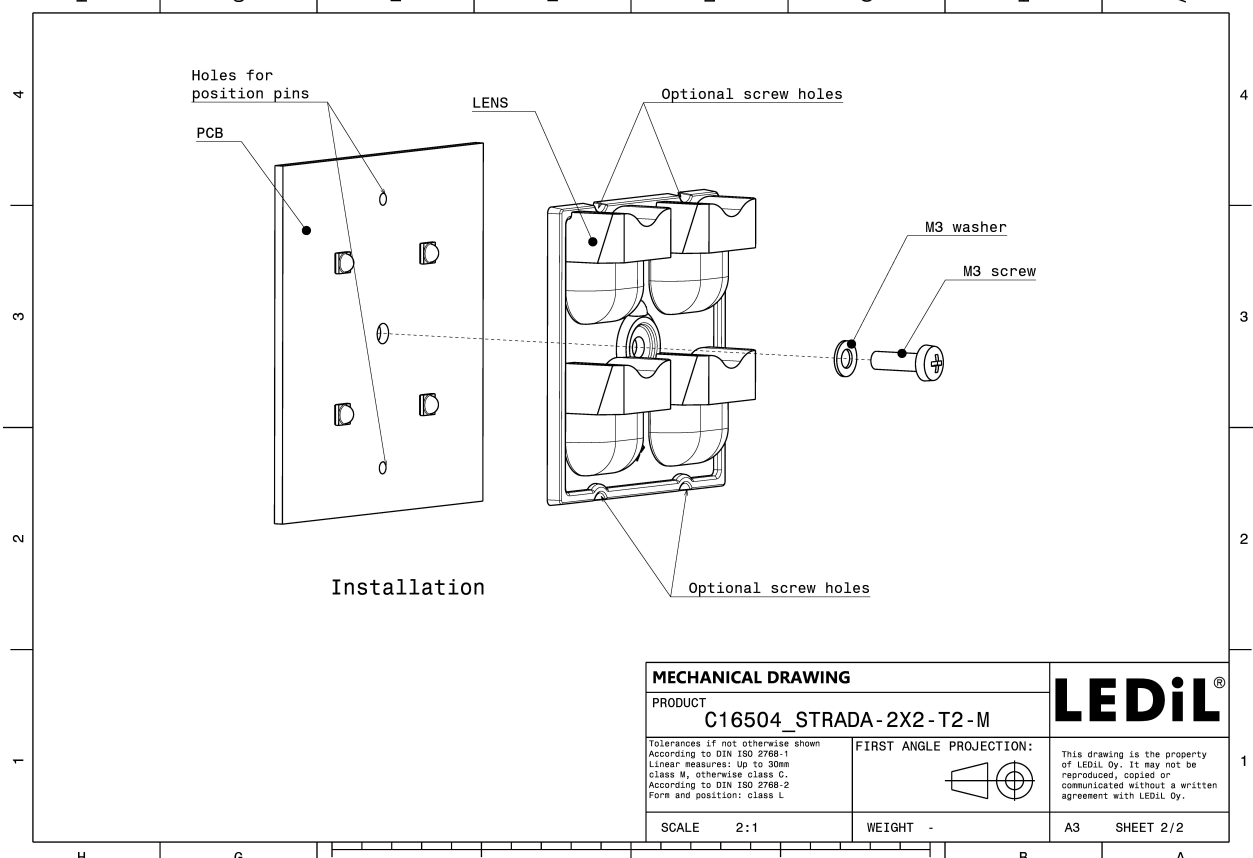
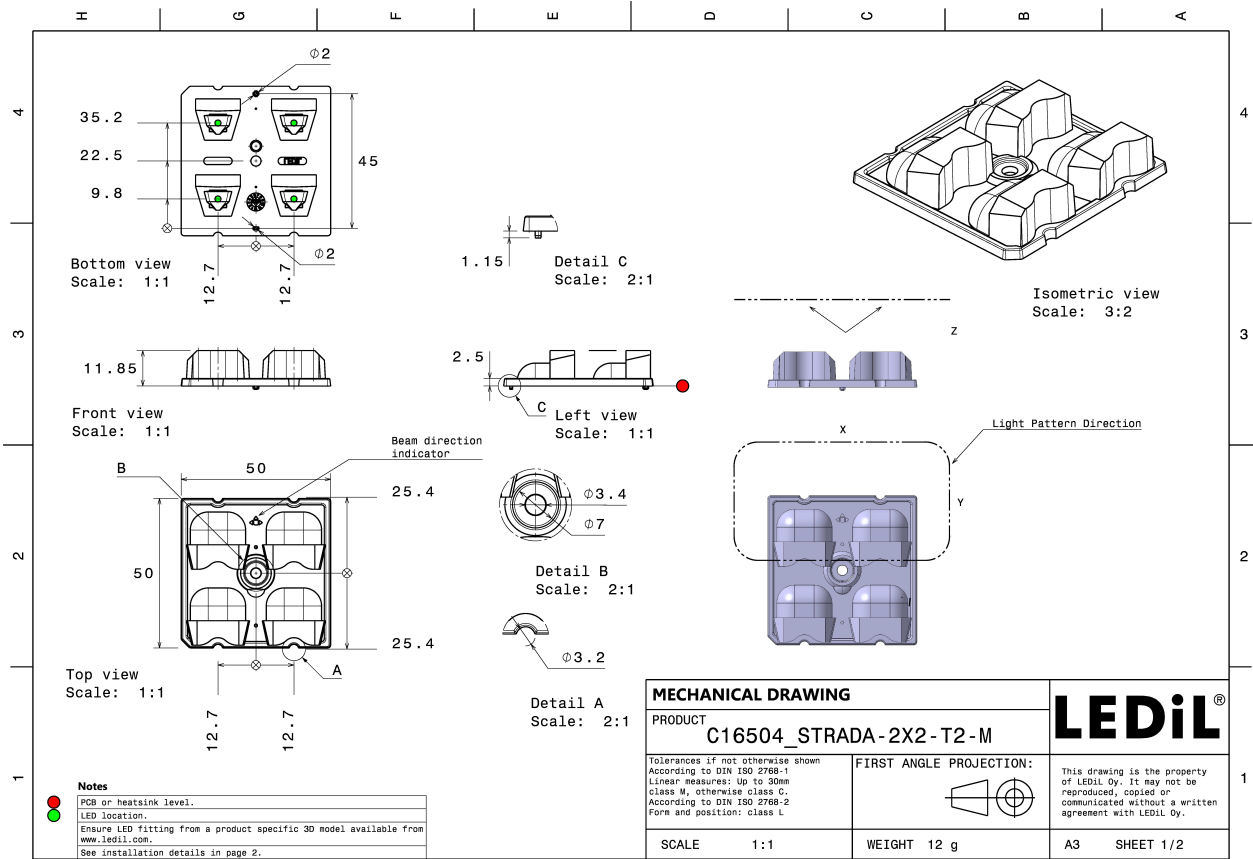

#### PHOTOMETRIC DATA (MEASURED):



LED XP-G3  
FWHM Asymmetric  
Efficiency 94 %  
Peak intensity 1.500 cd/lm  
Required components:

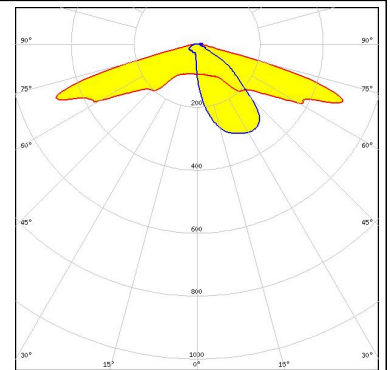

LED XT-E  
FWHM Asymmetric  
Efficiency 0 %  
Peak intensity 0.000 cd/lm  
Required components:



LED LUXEON TX  
FWHM Asymmetric  
Efficiency %  
Peak intensity 0.000 cd/lm  
Required components:

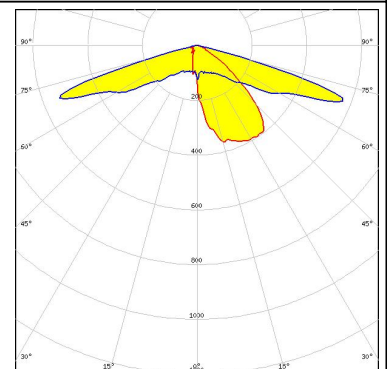

#### PHOTOMETRIC DATA (SIMULATED):



LED XP-G2  
 FWHM Asymmetric  
 Efficiency %  
 Peak intensity 0.000 cd/lm  
 Required components:

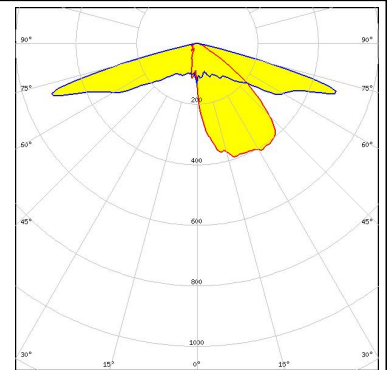

LED LUXEON 5050  
 FWHM Asymmetric  
 Efficiency 94 %  
 Peak intensity 0.850 cd/lm  
 Required components:

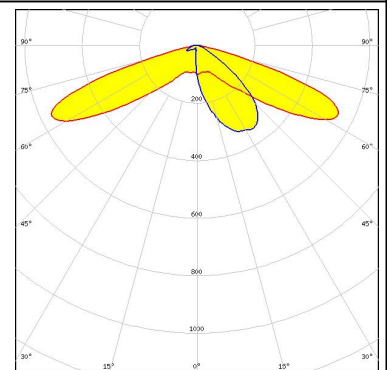

LED LUXEON 5050  
 FWHM Asymmetric  
 Efficiency 84 %  
 Peak intensity 0.690 cd/lm  
 Required components:  
 Undefined Manufacturer: Protective Plate, Glass

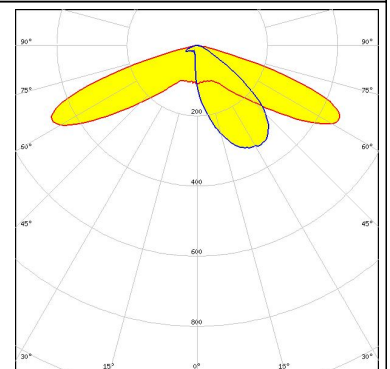

LED NVSxx19B/NVSxx19C  
 FWHM Asymmetric  
 Efficiency %  
 Peak intensity 0.000 cd/lm  
 Required components:

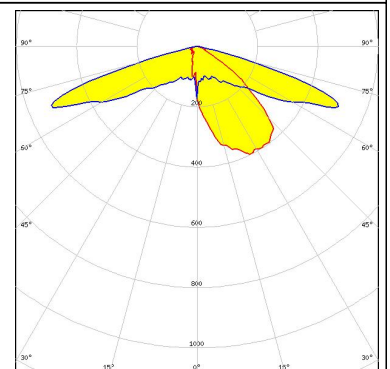

#### PHOTOMETRIC DATA (SIMULATED):

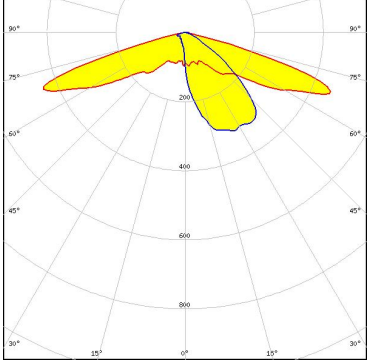
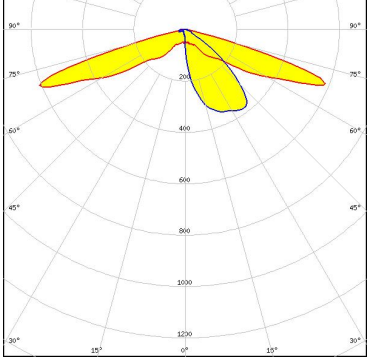
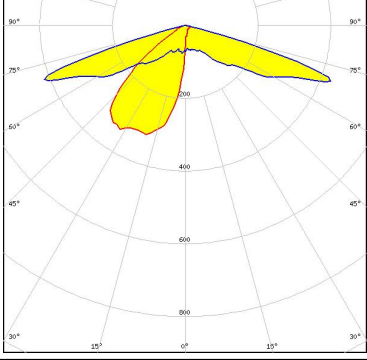
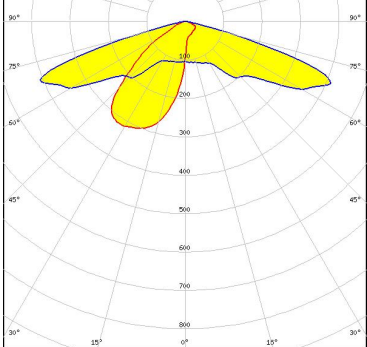
<p><b>NICHIA</b></p> <p>LED NVSxx19B/NVSxx19C FWHM Asymmetric Efficiency 82 % Peak intensity 0.950 cd/lm Required components: C12479_MIRELLA-DL Undefined Manufacturer: Protective Plate, Glass</p>	
<p><b>OSRAM</b> Opto Semiconductors</p> <p>LED Oslon Square Gen3 FWHM Asymmetric Efficiency 94 % Peak intensity 1.400 cd/lm Required components:</p>	
<p><b>PHILIPS</b></p> <p>LED Fortimo FastFlex LED board 2x8 DA G4 FWHM Asymmetric Efficiency 80 % Peak intensity 1.240 cd/lm Required components: Undefined Manufacturer: Protective Plate, Glass</p>	
<p><b>PHILIPS</b></p> <p>LED Fortimo FastFlex LED board 2x8 DAX G4 FWHM Asymmetric Efficiency 83 % Peak intensity 1.080 cd/lm Required components: Undefined Manufacturer: Protective Plate, Glass</p>	

#### PHOTOMETRIC DATA (SIMULATED):

### SAMSUNG

LED LH351C  
FWHM Asymmetric  
Efficiency 88 %  
Peak intensity 1.000 cd/lm  
Required components:  
Undefined Manufacturer: Protective Plate, Glass

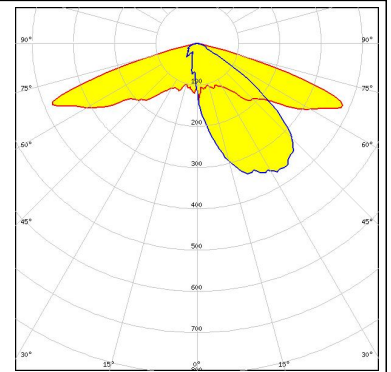

LED Z5M1/Z5M2  
FWHM Asymmetric  
Efficiency %  
Peak intensity 0.000 cd/lm  
Required components:

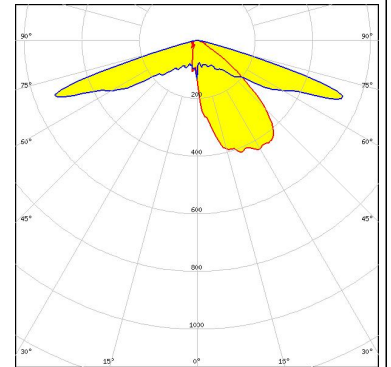

### TRIDONIC

LED RLE G1 49x223mm 4000lm xxx EXC OTD  
FWHM Asymmetric  
Efficiency 94 %  
Peak intensity 1.600 cd/lm  
Required components:

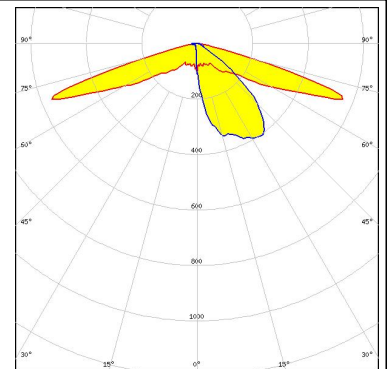

#### GENERAL INFORMATION:

NOTE: The typical beam angle will be changed by different color, chip size and chip position tolerance. The typical total beam angle is the full angle measured where the luminous intensity is half of the peak value.

#### MATERIALS:

As part of our continuous research and improvement processes, and to ensure the best possible quality and availability of our products, LEDiL reserves the right to change material grades without notice.

#### PRODUCT DATA USER AGREEMENT AND DISCLAIMER:

The measured data in the provided downloadable LEDiL Product Datasheets and Mechanical 2D-Drawings is rounded and provided as reference for planning. LEDiL Oy's optical specifications have been verified by conducting performance testing of the products in accordance with the company's quality system. The reported data are averaged results of multiple measurements with typical variation. LEDiL Oy reserves the right to without prior notification make changes and improvements to its products.

LEDiL Oy assumes neither warranty, nor guarantee nor any other liability of any kind for the contents and correctness of the provided data. The provided data has been generated with highest diligence but the provided data may in reality not represent the complete possible variation range of all intrinsic parameters. Therefore, in certain cases a deviation from the provided data could occur.

LEDiL Oy reserves the right to undertake technical changes of its products without further notification which could lead to changes in the provided data. LEDiL Oy assumes no liability of any kind for the possible deviation from any provided data or any other damage resulting from the usage of the provided data.

The user agrees to this disclaimer and user agreement with the download or usage of the provided files.

#### LEDiL Oy

Joensuunkatu 13  
FI-24240 SALO  
Finland

#### LEDiL Inc.

228 West Page Street  
Suite D  
Sycamore IL 60178  
USA

#### Local sales and technical support

[www.ledil.com/  
where\\_to\\_buy](http://www.ledil.com/where_to_buy)

#### Shipping locations

Salo, Finland  
Hong Kong, China

#### Distribution Partners

[www.ledil.com/  
where\\_to\\_buy](http://www.ledil.com/where_to_buy)