

Photoelectrics Through-beam Type PD30CNT15....SA

CARLO GAVAZZI



- Miniature sensor range
- Range: 15 m
- Sensitivity adjustment by potentiometer
- Modulated, infrared light 850 nm
- Supply voltage: 10 to 30 VDC
- Output: 100 mA, NPN or PNP preset
- Make and break switching function
- LED indication for output, stability and power ON
- Protection: Short-circuit, reverse polarity and transients
- Cable and plug versions
- Excellent EMC performance



Product Description

The PD30CNT15 sensor family comes in a compact 10 x 30 x 20 mm reinforced PMMA/ABS housing. The sensors are useful in applications where high-accuracy detection as well as small size is required. Compact housing and high power LED for excellent performance-size ratio.

The potentiometer function for adjustment of the sensitivity makes the sensors highly flexible. The output type is preset (NPN or PNP), and the output switching function is NO and NC output.

Ordering Key

PD30CNT15NAM5SA

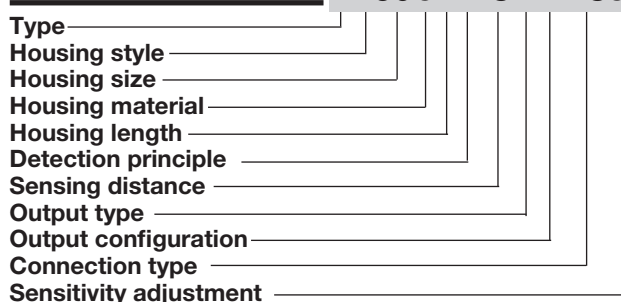

Type Selection

Housing W x H x D	Range S _n	Connection	Ordering no. Emitter	Ordering no. NPN Make and break switching	Ordering no. PNP Make and break switching
10 x 30 x 20 mm	15 m	Cable	PD 30 CNT 15	PD 30 CNT 15 NASA	PD 30 CNT 15 PASA
10 x 30 x 20 mm	15 m	Plug	PD 30 CNT 15 M5	PD 30 CNT 15 NAM5SA	PD 30 CNT 15 PAM5SA

Note: Emitter, receiver and connector to be ordered separately

Specifications Receiver EN 60947-5-2

Rated operating distance (S_n) PD30CNT emitter	≤ 15 m	OFF-state current (I_r)	≤ 100 μA
Adjustment range	3 to 15 m	Voltage drop (U_d)	≤ 2 VDC @ I _e max
Blind zone PD30CNT emitter	None	Protection	Short-circuit, reverse polarity and transients
Sensitivity Electrical adjustment Mechanical adjustment	210° 240°	Ambient light	≤ 10,000 lux
Temperature drift	≤ 0.2%/°C	Operating frequency (f)	≤ 500 Hz
Hysteresis (H)	5% to 20%	Response time OFF-ON (t _{ON}) ON-OFF (t _{OFF})	≤ 1 ms ≤ 1 ms
Rated operational volt. (U_B)	10 to 30 VDC (ripple included)	Power ON delay (t_v)	≤ 200 ms
Ripple (U_{ripple})	≤ 10%	Output function Open collector	NPN or PNP by sensor type
Output current Continuous (I _a) Short-time (I)	≤ 100 mA ≤ 100 mA (max. load capacity 100 nF)	Output switching function	N.O. and N.C.
No load supply current (I_o)	≤ 20 mA @ U _B max	Indication Output ON Power ON	LED, yellow Signal stability ON and LED, green. See curve for condition of stability
Minimum operational current (I_m)	≤ 0.5 mA		



Specifications Emitter EN 60947-5-2

Rated operational volt. (U_B)	10 to 30 VDC (ripple included)	Light spot	110 mm @ 1.5 meters distance
Ripple (U_{rpp})	$\leq 10\%$	Power ON delay (t_v)	≤ 200 ms
No load supply current (I_o)	≤ 25 mA @ U_B max	Protection	Reverse polarity and transients
Light source	LED, 850 nm	Indication	LED, green
Light type	Infrared, modulated	Power ON	
Emitter angle	$\pm 2^\circ$ @ half sensing distance		

General Specifications EN 60947-5-2

Environment		Housing material	
Installation category	III (IEC 60664/60664A; 60947-1)	Body	ABS Light Grey
Pollution degree	3 (IEC 60664/60664A; 60947-1)	Frontglas	PMMA Red
Degree of protection	IP 67 (IEC 60529; 60947-1)	Trimmer shaft	POM Dark Grey
Ambient temperature		Connection	
Operating	-25° to +60°C (-13° to +140°F)	Cable	PVC, black, 2 m 4 x 0.14 mm ² , $\varnothing = 3.3$ mm
Storage	-40° to +70°C (-40° to +158°F)	Plug	M8, 4-pin (CON. 54-series)
Vibration	10 to 150 Hz, 1.0 mm/15 G (IEC 60068-2-6)	Weight	
Shock	30 g / 11ms, 3 pos, 3 neg per axis (IEC 60068-2-6, 60068-2-32)	Cable version	≤ 50 g
Rated insulation voltage	≤ 500 VAC (rms)	Plug version	≤ 20 g
		CE-marking	Yes
		Approvals	cULus (UL508 + CSA)

Operation Diagram

T_v = Power ON delay

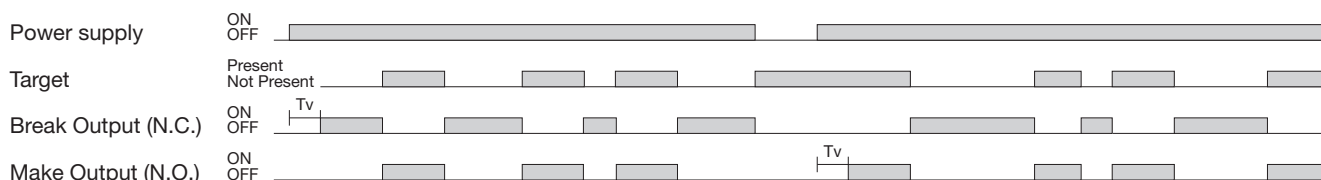

Signal Stability Indication

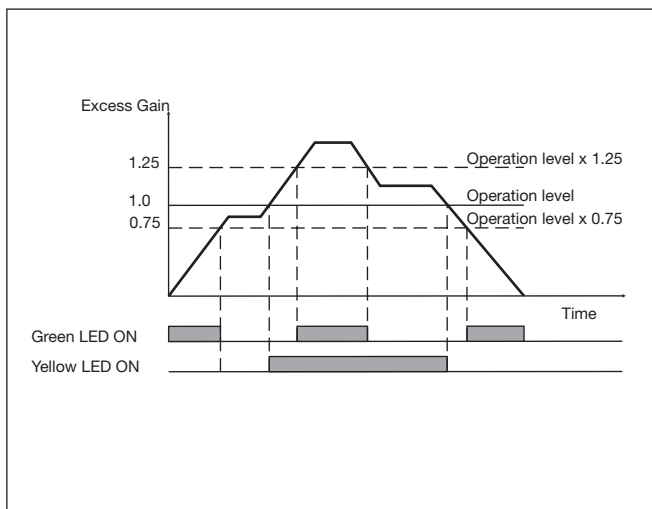

Wiring Diagrams

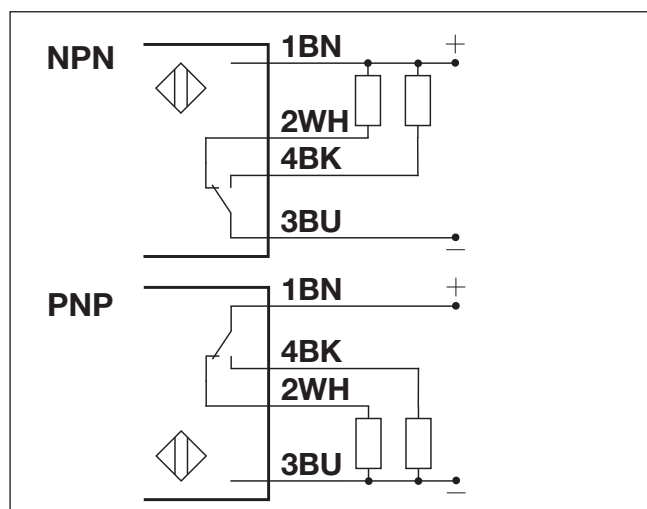

Detection Diagram

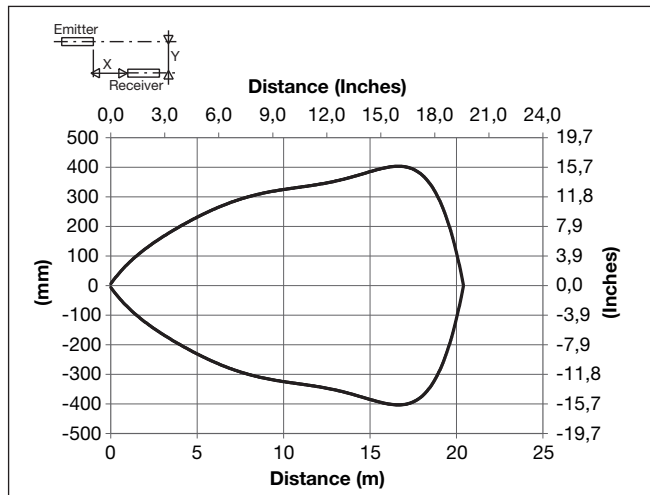

Excess Gain

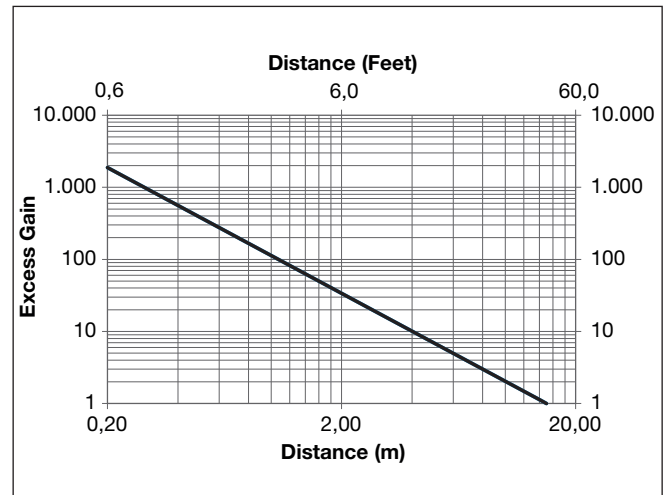

Dimensions

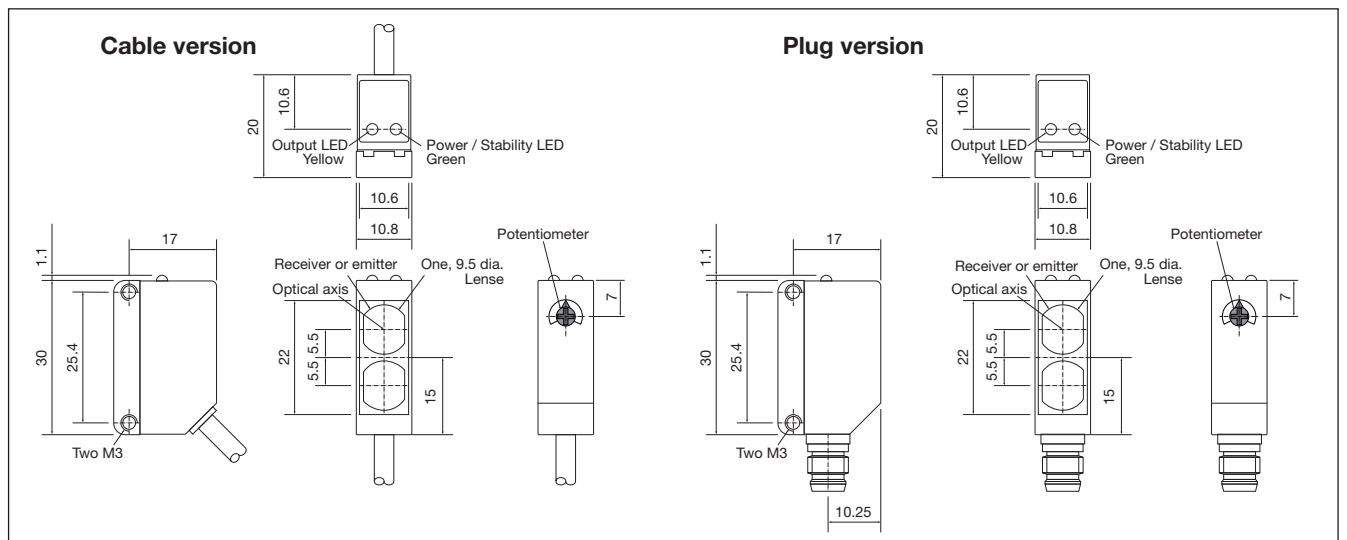

Installation Hints

<p>To avoid interference from inductive voltage / current peaks, separate the proximity switch cables from any other power cables. E.g. Engine, contactor or solenoid cables</p>	<p>Relief of the cable strain</p> <p>The cable should not be pulled</p>	<p>Protection of the sensing face</p> <p>A proximity switch should not serve as mechanical stop</p>	<p>Sensor mounted on a mobile carrier</p> <p>Any repetitive flexing of the cable should be avoided</p>
--	---	---	--

Accessories

- Mounting bracket APD30-MB1 or APD30-MB2 to be purchased separately.

Delivery Contents

- Photoelectric switch: PD30CNT15 ...
- Screwdriver (Receiver only)
- **Packaging:** Plastic bag