

SPEC

| | |
|----------|-----------------------|
| Spec No. | TQ3C-8EAF0-E1DFF43-00 |
| Date | August 23, 2012 |

TYPE : TCG043WQLBAAFA-GA50

< 4.3 inch WQVGA transmissive color TFT
with LED backlight / and touch panel.>

CONTENTS

1. Application
2. Construction and outline
3. Mechanical specifications
4. Absolute maximum ratings
5. Electrical characteristics
6. Optical characteristics
7. Interface signals
8. Input timing characteristics
9. Backlight characteristics
10. Design guidance for analog touch panel
11. Lot number identification
12. Warranty
13. Precautions for use
14. Reliability test data
15. Outline drawing



KYOCERA CORPORATION
LCD DIVISION

This specification is subject to change without notice.
Consult Kyocera before ordering.

| Original Issue Date | Designed by: Engineering dept. | | | Confirmed by: QA dept. | |
|---------------------|--------------------------------|--------------------|--------------------|------------------------|----------------|
| | Prepared | Checked | Approved | Checked | Approved |
| August 23, 2012 | <i>H. Mori</i> | <i>Y. Yamazaki</i> | <i>M. Fujitani</i> | <i>I. Kamae</i> | <i>H. Itoh</i> |

Warning

1. This Kyocera LCD module has been specifically designed for use only in electronic devices and industrial machines in the area of audio control, office automation, industrial control, home appliances, etc. The module should not be used in applications where the highest level of safety and reliability are required and module failure or malfunction of such module results in physical harm or loss of life, as well as enormous damage or loss. Such fields of applications include, without limitation, medical, aerospace, communications infrastructure, atomic energy control. Kyocera expressly disclaims any and all liability resulting in any way to the use of the module in such applications.

2. Customer agrees to indemnify, defend and hold Kyocera harmless from and against any and all actions, claims, damages, liabilities, awards, costs, and expenses, including legal expenses, resulting from or arising out of Customer's use, or sale for use, or Kyocera modules in applications.

Caution

1. Kyocera shall have the right, which Customer hereby acknowledges, to immediately scrap or destroy tooling for Kyocera modules for which no Purchase Orders have been received from the Customer in a two-year period.

| | | |
|-----------------------------------|---------------------------------|-----------|
| Spec No. TQ3C-8EAF0-E1DFF43-00 | Part No. TCG043WQLBAAFA-GA50 | Page - |
|-----------------------------------|---------------------------------|-----------|

Revision record

| Date | | Designed by : Engineering dept. | | | Confirmed by : QA dept. | |
|---------|------|---------------------------------|--------------|----------|-------------------------|----------|
| | | Prepared | Checked | Approved | Checked | Approved |
| | | | | | | |
| Rev.No. | Date | Page | Descriptions | | | |
| | | | | | | |

1. Application

This document defines the specification of TCG043WQLBAAFA-GA50. (RoHS Compliant)

2. Construction and outline

| | |
|--------------------|--|
| LCD | : Transmissive color dot matrix type TFT |
| Backlight system | : LED |
| Polarizer | : Glare treatment |
| Additional circuit | : Timing controller, Power supply (3.3V input) (without constant current circuit for LED Backlight) |
| Touch panel | : Analog type, Non-Glare treatment |

3. Mechanical specifications

3-1. LCD

| Item | Specification | Unit |
|-----------------------|---|------|
| Outline dimensions 1) | 105.5(W)×67.2(H)×7.7(D) | mm |
| Active area | 95.04(W)×53.856(H) (10.9cm/4.3 inch(Diagonal)) | mm |
| Dot format | 480×(R,G,B)(W)×272(H) | dot |
| Dot pitch | 0.198(W)×0.198(H) | mm |
| Base color 2) | Normally White | - |
| Mass | 100 | g |

1) Projection not included. Please refer to outline for details.

2) Due to the characteristics of the LCD material, the color varies with environmental temperature.

3-2. Touch panel

| Item | Specification | Unit |
|------------------|--------------------------------------|------|
| Input | Radius-0.8 stylus or Finger | - |
| Actuation Force | 0.05 ~ 0.8 | N |
| Transmittance | Typ. 80 | % |
| Surface hardness | Pencil hardness 2H or more according | - |

4. Absolute maximum ratings

4-1. Electrical absolute maximum ratings

| Item | Symbol | Min. | Max. | Unit |
|--------------------------------|-----------------|------|-----------------|------|
| Supply voltage | V _{DD} | -0.5 | 5.0 | V |
| Input signal voltage 1) | V _{IN} | 0 | V _{DD} | V |
| LED forward current 2) 3) | I _F | - | 100 | mA |
| Supply voltage for touch panel | V _{TP} | 0 | 6.0 | V |
| Input current of touch panel | I _{TP} | 0 | 0.5 | mA |

- 1) Input signal : CK, R0 ~ R7, G0 ~ G7, B0 ~ B7, HSD, VSD, DE
- 2) For each "AN-CA"
- 3) Do not apply reversed voltage.

4-2. Environmental absolute maximum ratings

| Item | Symbol | Min. | Max. | Unit |
|--------------------------|------------------|------|------|------|
| Operating temperature 1) | T _{OP} | -20 | 70 | °C |
| Storage temperature 2) | T _{STO} | -30 | 80 | °C |
| Operating humidity 3) | H _{OP} | 10 | 4) | %RH |
| Storage humidity 3) | H _{STO} | 10 | 4) | %RH |
| Vibration | - | 5) | 5) | - |
| Shock | - | 6) | 6) | - |

- 1) Operating temperature means a temperature which operation shall be guaranteed. Since display performance is evaluated at 25°C, another temperature range should be confirmed.
- 2) Temp. = -30°C < 48h , Temp. = 80°C < 168h
Store LCD at normal temperature/humidity. Keep them free from vibration and shock.
An LCD that is kept at a low or a high temperature for a long time can be defective due to other conditions, even if the low or high temperature satisfies the standard.
(Please refer to "Precautions for Use" for details.)
- 3) Non-condensing
- 4) Temp. 40°C, 85%RH Max.
Temp. > 40°C, Absolute humidity shall be less than 85%RH at 40°C.
- 5)

| | | |
|-----------------|-------------|---|
| Frequency | 10 ~ 55 Hz | Acceleration value (0.3 ~ 9 m/s ²) |
| Vibration width | 0.15mm | |
| Interval | 10-55-10 Hz | 1 minutes |

2 hours in each direction X, Y, Z (6 hours total)

EIAJ ED-2531

- 6) Acceleration: 490 m/s², Pulse width: 11 ms
3 times in each direction: ±X, ±Y, ±Z
EIAJ ED-2531

6. Optical characteristics

Measuring spot = 6.0mm, Temp. = 25°C

| Item | Symbol | Condition | Min. | Typ. | Max. | Unit |
|--|-------------------|--------------|-------|-------|-------|-------------------|
| Response time | $\tau_r + \tau_d$ | = =0° | - | 25 | - | ms |
| Viewing angle range View direction : 6 o'clock (Gray inversion) | UPPER | CR 10 | - | 60 | - | deg. |
| | LOWER | | - | 65 | - | |
| | LEFT | | - | 70 | - | deg. |
| | ϕ RIGHT | | - | 70 | - | |
| Contrast ratio | CR | = =0° | 245 | 350 | - | - |
| Brightness | L | IF=60mA/Line | 440 | 640 | - | cd/m ² |
| Chromaticity coordinates | Red | x | = =0° | 0.535 | 0.585 | 0.635 |
| | | y | | 0.290 | 0.340 | 0.390 |
| | Green | x | = =0° | 0.310 | 0.360 | 0.410 |
| | | y | | 0.520 | 0.570 | 0.620 |
| | Blue | x | = =0° | 0.100 | 0.150 | 0.200 |
| | | y | | 0.085 | 0.135 | 0.185 |
| | White | x | = =0° | 0.270 | 0.320 | 0.370 |
| | | y | | 0.300 | 0.350 | 0.400 |

6-1. Definition of contrast ratio

$$\text{CR(Contrast ratio)} = \frac{\text{Brightness with all pixels "White"}}{\text{Brightness with all pixels "Black"}}$$

6-2. Definition of response time

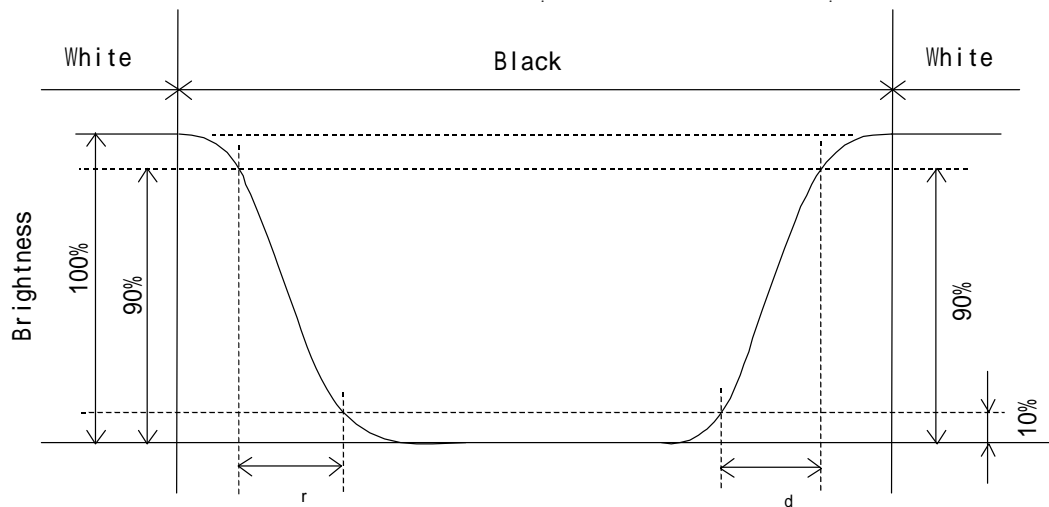

6-3. Definition of viewing angle

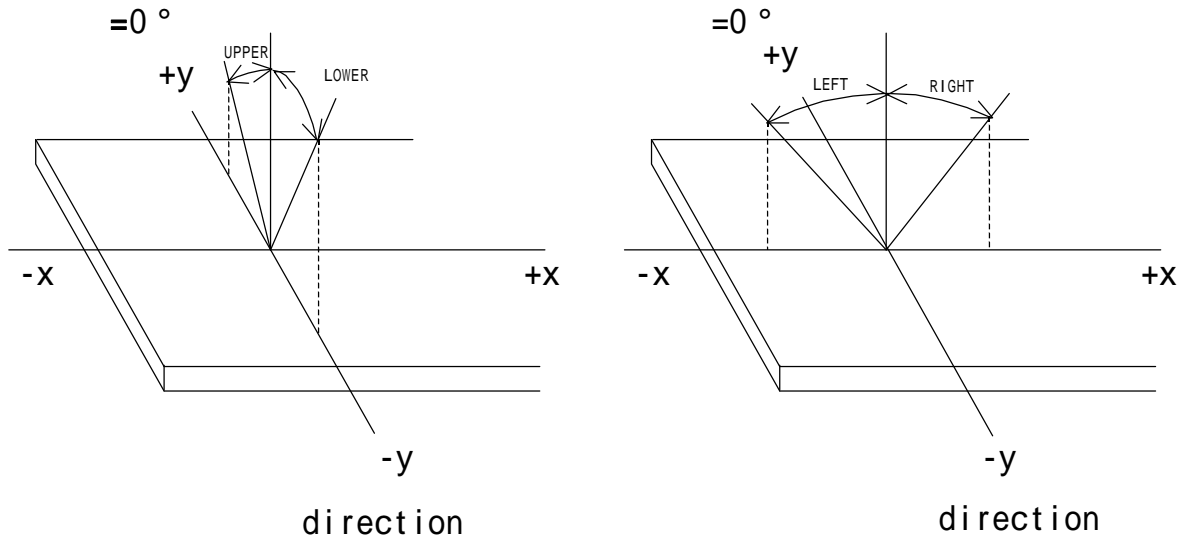

6-4. Brightness measuring points

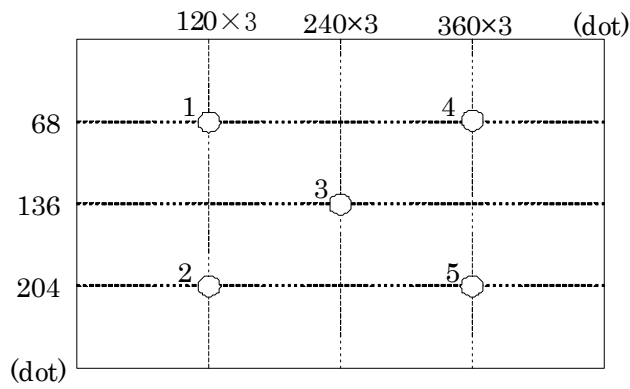

- 1) Rating is defined as the white brightness at center of display screen(3).
- 2) Measured 5 minutes after the LED is powered on. (Ambient temp. = 25°C)

7. Interface signals

7-1. LCD

| No. | Symbol | Description | Note |
|-----|-----------------|--|------|
| 1 | CA | Cathode | |
| 2 | AN | Anode | |
| 3 | GND | GND | |
| 4 | V _{DD} | Power supply | |
| 5 | R0 | RED data signal (LSB) | |
| 6 | R1 | RED data signal | |
| 7 | R2 | RED data signal | |
| 8 | R3 | RED data signal | |
| 9 | R4 | RED data signal | |
| 10 | R5 | RED data signal | |
| 11 | R6 | RED data signal | |
| 12 | R7 | RED data signal (MSB) | |
| 13 | G0 | GREEN data signal (LSB) | |
| 14 | G1 | GREEN data signal | |
| 15 | G2 | GREEN data signal | |
| 16 | G3 | GREEN data signal | |
| 17 | G4 | GREEN data signal | |
| 18 | G5 | GREEN data signal | |
| 19 | G6 | GREEN data signal | |
| 20 | G7 | GREEN data signal (MSB) | |
| 21 | B0 | BLUE data signal (LSB) | |
| 22 | B1 | BLUE data signal | |
| 23 | B2 | BLUE data signal | |
| 24 | B3 | BLUE data signal | |
| 25 | B4 | BLUE data signal | |
| 26 | B5 | BLUE data signal | |
| 27 | B6 | BLUE data signal | 1) |
| 28 | B7 | BLUE data signal (MSB) | |
| 29 | GND | GND | |
| 30 | DCLK | Pixel clock | |
| 31 | DISP | DISP="H", Display on DISP="L", Display off, All outputs are High-Z. | |
| 32 | HSD | Horizontal synchronous signal | |
| 33 | VSD | Vertical synchronous signal | |
| 34 | DE | Data Enable | |
| 35 | NC | No connect | |
| 36 | GND | GND | |
| 37 | NC | No connect | |
| 38 | NC | No connect | |
| 39 | NC | No connect | |
| 40 | NC | No connect | |

LCD connector : 08 6212 040 340 800+ (KYOCERA Connector Products)

7-2. Touch panel

| No. | Symbol | Description |
|-----|--------|------------------|
| 1 | xR | x-Right terminal |
| 2 | yL | y-Lower terminal |
| 3 | xL | x-Left terminal |
| 4 | yU | y-Upper terminal |

Touch panel side connector : 1mm pitch

Recommended matching connector : 08 6262 004 940 846+ (KYOCERA Connector Products)

8. Input timing characteristics

8-1. Clock and Data Input Timing Diagram

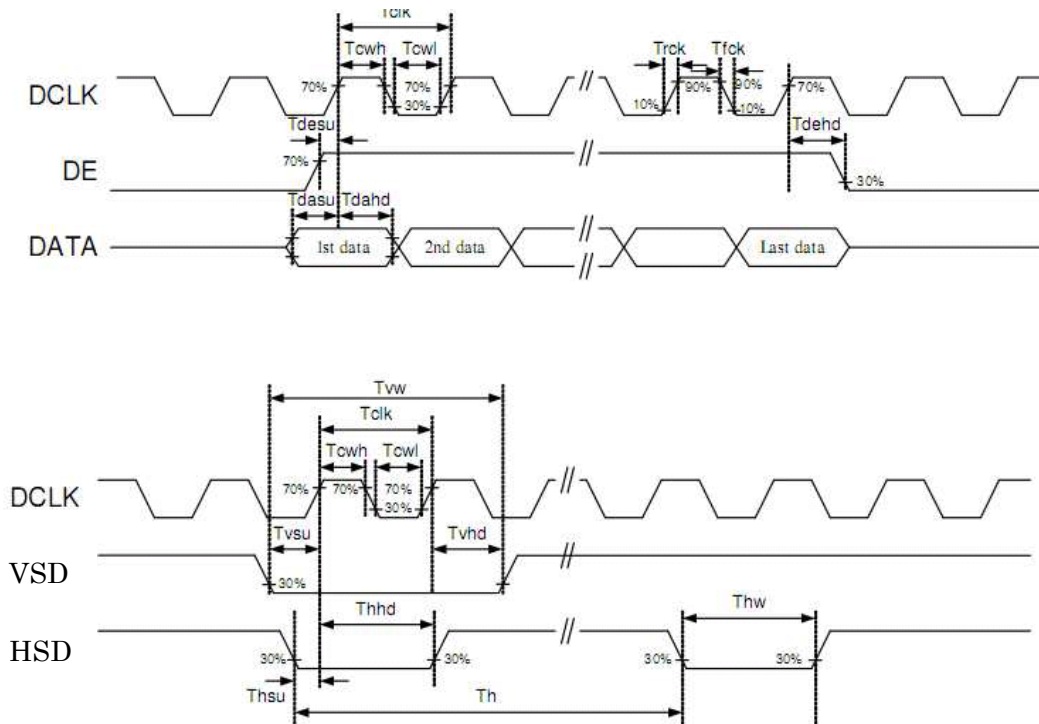

8-2. AC Electrical characteristics

| Parameters | Symbol | Min. | Typ. | Max. | Unit | Condition |
|---------------------|--------|------|------|------|------|------------|
| Input Output timing | | | | | | |
| DCLK clock time | Tclk | 33.3 | - | - | ns | DCLK=30MHz |
| Clock rising time | Trck | - | - | 9 | ns | |
| Clock falling time | Tfck | - | - | 9 | ns | |
| HSD width | Thw | 1 | - | - | DCLK | |
| HSD period time | Th | 55 | 60 | 65 | μs | |
| HSD setup time | Thsu | 12 | - | - | ns | |
| HSD hold time | Thhd | 12 | - | - | ns | |
| VSD width | Tvw | 1 | - | - | Th | |
| VSD setup time | Tvsu | 12 | - | - | ns | |
| VSD hold time | Tvhhd | 12 | - | - | ns | |
| Data setup time | Tdasu | 12 | - | - | ns | |
| Data hold time | Tdahd | 12 | - | - | ns | |
| DE setup time | Tdesu | 12 | - | - | ns | |
| DE hold time | Tdshd | 12 | - | - | ns | |

8-3. Output timing table

| Parameters | Symbol | Min. | Typ. | Max. | Unit | Condition |
|-----------------|--------|------|------|------|------|-----------|
| DCLK frequency | Fclk | 5 | 9 | 12 | MHz | |
| DCLK cycle time | Tclk | 83 | 110 | 200 | ns | |
| DCLK pulse duty | Tcwh | 40 | 50 | 60 | % | |

8-4. Data Input format

Vertical input timing

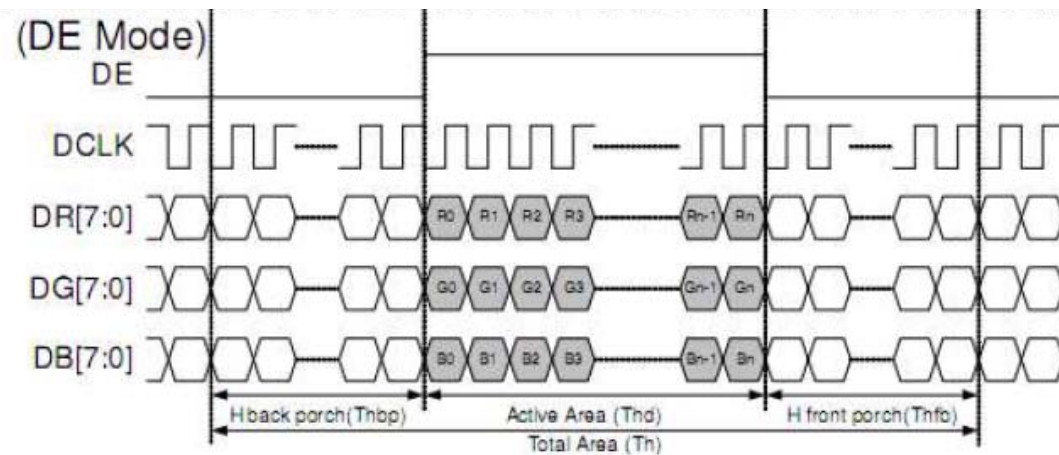
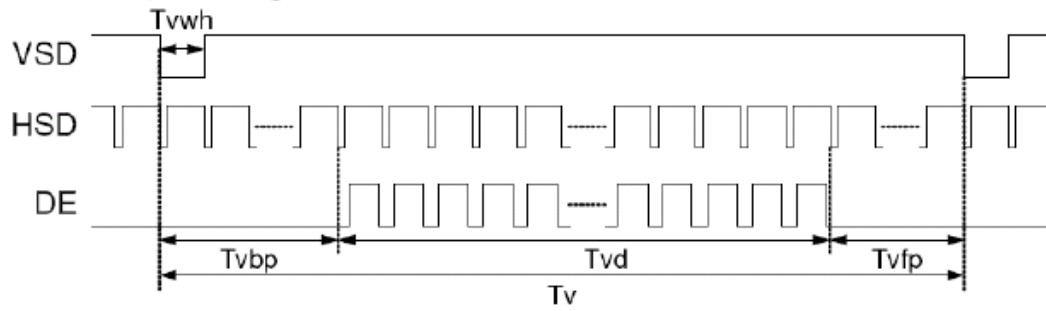

| Parameters | Symbol | Min. | Typ. | Max. | Unit | Condition |
|------------------|--------|------|------|------|------|-----------|
| DCLK frequency | Fclk | 5 | 9 | 12 | MHz | |
| VSD period time | Tv | 277 | 288 | 400 | H | |
| VSD display area | Tvd | 272 | | | H | |
| VSD back porch | Tvbp | 3 | 8 | 31 | H | |
| VSD front porch | Tvfp | 2 | 8 | 97 | H | |
| HSD period time | Th | 520 | 525 | 800 | DCLK | |
| HSD display area | Thd | 480 | | | DCLK | |
| HSD back porch | Thbp | 36 | 40 | 255 | DCLK | |
| HSD front porch | thfp | 4 | 5 | 65 | DCLK | |

8-5. Power sequence

● Power sequence

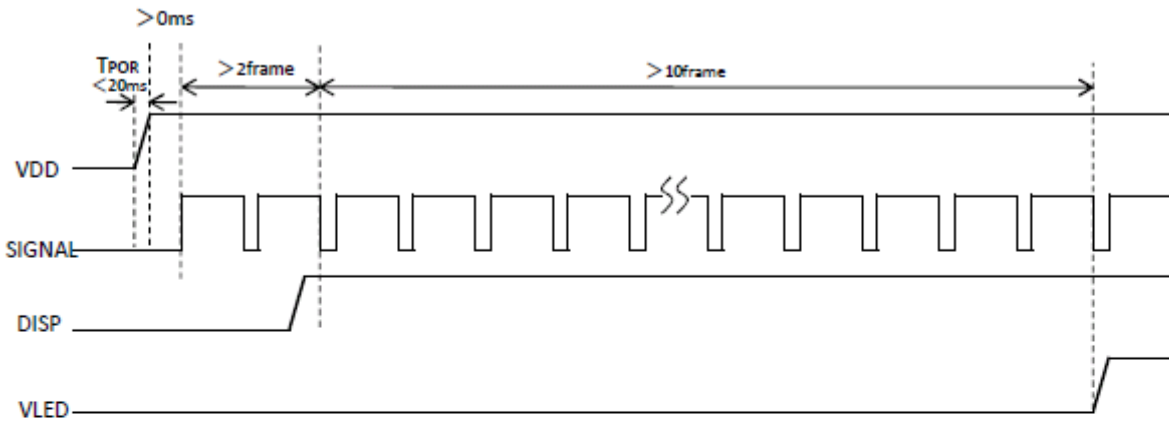

● Power off sequence

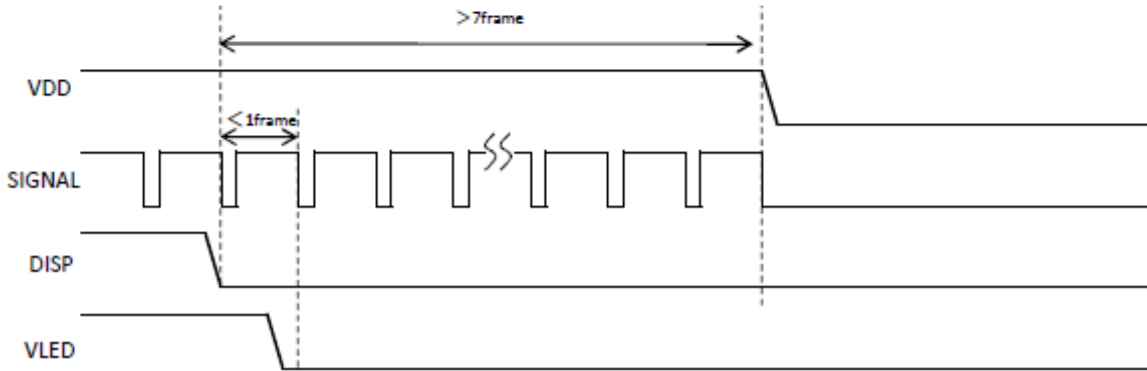

9. Backlight characteristics

| Item | Symbol | Min. | Typ. | Max. | Unit | Note |
|----------------------------|--------|------|--------|------|------|-----------------|
| Forward current 1) | IF | - | 60 | - | mA | Ta=-20 ~ 70°C |
| Forward voltage 1) | VF | - | 22.0 | 25.8 | V | IF=60mA, Ta=-20 |
| | | - | 21.0 | 24.7 | V | IF=60mA, Ta=25 |
| | | - | 20.4 | 24.1 | V | IF=60mA, Ta=70 |
| Operating life time 2), 3) | T | - | 70,000 | - | h | IF=60mA, Ta=25 |

- 1) For each "AN-CA"
- 2) When brightness decrease 50% of minimum brightness.
The average life of a LED will decrease when the LCD is operating at higher temperatures.
- 3) Life time is estimated data.(Condition : IF=60mA, Ta=25 in chamber).
- 4) An input current below 15mA may reduce the brightness uniformity of the LED backlight.
This is because the amount of light from each LED chip is different. Therefore, please evaluate carefully before finalizing the input current.

10. Design guidance for analog touch panel

10-1. Electrical (In customer's design, please remember the following considerations.)

- 1) Do not use the current regulated circuit.
- 2) Keep the current limit with top and bottom layer.
(Please refer to "Electrical absolute maximum ratings" for details.)
- 3) Analog touch panel can not sense two points touching separately.
- 4) A contact resistance is appeared at the touch point between top and bottom layer.
After this resistance has stable read of the touch panel position data.
- 5) Because noise of inverter or peripheral circuits may interfere signal of touch panel itself it is necessary to design carefully in advance to avoid these noise problem.

10-2. Software

- 1) Do the "User Calibration".
- 2) "User Calibration" may be needed with long term using.
Include "User Calibration" menu in your software.
- 3) When drawing a line with a stylus, there may be a slight discontinuity when the stylus passes over a spacer-dot. If necessary, please provide a compensation feature within your software.

10-3. Mounting on display and housing bezel

- 1) Do not use an adhesive tape to bond it on the front of touch panel and hang it to the housing bezel.
- 2) Never expand the touch panel top layer (PET-film) like a balloon by internal air pressure.
The life of the touch panel will be extremely short.
- 3) If a dew will be on the heat-sealed area or exposed traces at the end of a flexible tail, the migration of silver can occur. This will cause sometimes a short circuit.
- 4) Must maintain a gap between inside of bezel and touch panel to avoid malfunction or electrode damage of touch panel.

11. Lot number identification

The lot number shall be indicated on the back of the backlight case of each LCD.

TCG043WQLBAAFA-GA50 - □□ - □□ - □ MADE IN □□□□□
 ↓↓ ↓ ↓ ↓
 1 2 3 4 5

No1. - No5. above indicate
 1. Year code
 2. Month code
 3. Date
 4. Version Number
 5. Country of origin (Japan or China)

| | | | | | | |
|------|------|------|------|------|------|------|
| Year | 2012 | 2013 | 2014 | 2015 | 2016 | 2017 |
| Code | 2 | 3 | 4 | 5 | 6 | 7 |

| | | | | | | |
|-------|------|------|------|------|-----|------|
| Month | Jan. | Feb. | Mar. | Apr. | May | Jun. |
| Code | 1 | 2 | 3 | 4 | 5 | 6 |

| | | | | | | |
|-------|------|------|------|------|------|------|
| Month | Jul. | Aug. | Sep. | Oct. | Nov. | Dec. |
| Code | 7 | 8 | 9 | X | Y | Z |

12. Warranty

12-1. Incoming inspection

Please inspect the LCD within one month after your receipt.

12-2. Production warranty

Kyocera warrants its LCD's for a period of 12 months from the ship date. Kyocera shall, by mutual agreement, replace or re-work defective LCD's that are shown to be Kyocera's responsibility.

| | | |
|-----------------------------------|---------------------------------|------------|
| Spec No. TQ3C-8EAF0-E1DFF43-00 | Part No. TCG043WQLBAAFA-GA50 | Page 13 |
|-----------------------------------|---------------------------------|------------|

13. Precautions for use

13-1. Installation of the LCD

- 1) The LCD shall be installed so that there is no pressure on the LSI chips.
- 2) The LCD shall be installed flat, without twisting or bending.

13-2. Static electricity

- 1) Since CMOS ICs are mounted directly onto the LCD glass, protection from static electricity is required.
- 2) Workers should use body grounding. Operator should wear ground straps.

13-3. LCD operation

- 1) The LCD shall be operated within the limits specified. Operation at values outside of these limits may shorten life, and/or harm display images.
- 2) Please select the best display pattern based on your evaluation because flicker, lines or nonuniformity or unevenness can be visible depending on display patterns.

13-4. Storage

- 1) The LCD shall be stored within the temperature and humidity limits specified.
Store in a dark area, and protect the LCD from direct sunlight or fluorescent light.
- 2) Always store the LCD so that it is free from external pressure onto it.

13-5. Usage

- 1) **DO NOT** store in a high humidity environment for extended periods. Polarizer degradation bubbles, and/or peeling off of the polarizer may result.
- 2) Do not push or rub the touch panel's surface with hard to sharp objects such as knives, or the touch panel may be scratched.
- 3) When the touch panel is dirty, gently wipe the surface with a soft cloth, sometimes moistened by mild detergent or alcohol. If a hazardous chemical is dropped on the touch panel by mistake, wipe it off right away to prevent human contact.
- 4) Touch panel edges are sharp. Handle the touch panel with enough care to prevent cuts.
- 5) Always keep the LCD free from condensation during testing. Condensation may permanently spot or stain the polarizer.
- 6) Do not disassemble LCD because it will result in damage.
- 7) This Kyocera LCD has been specifically designed for use in general electronic devices, but not for use in a special environment such as usage in an active gas. Hence, when the LCD is supposed to be used in a special environment, evaluate the LCD thoroughly beforehand and do not expose the LCD to chemicals such as an active gas.
- 8) Please do not use solid-base image pattern for long hours because a temporary afterimage may appear. We recommend using screen saver etc. in cases where a solid-base image pattern must be used.
- 9) Liquid crystal may leak when the LCD is broken. Be careful not to let the fluid go into your eyes and mouth. In the case the fluid touches your body; rinse it off right away with water and soap.

14. Reliability test data

| Test item | Test condition | Test time | Judgement |
|--------------------------------|---|-------------------|--|
| High temp. atmosphere | 80°C | 240h | Display function : No defect Display quality : No defect Current consumption : No defect |
| Low temp. atmosphere | -30°C | 240h | Display function : No defect Display quality : No defect Current consumption : No defect |
| High temp. humidity atmosphere | 40°C 90% RH | 240h | Display function : No defect Display quality : No defect Current consumption : No defect |
| Temp. cycle | -30°C 0.5h R.T. 0.5h 80°C 0.5h | 10cycles | Display function : No defect Display quality : No defect Current consumption : No defect |
| High temp. operation | 70°C | 500h | Display function : No defect Display quality : No defect Current consumption : No defect |
| Point Activation life | Silicon rubber, Tip : R = 4.0 Hitting force 3N Hitting speed 2 time/s | one million times | Terminal resistance : No defect Insulation resistance : No defect Linearity : No defect Actuation Force : No defect |

- 1) Each test item uses a test LCD only once. The tested LCD is not used in any other tests.
- 2) The LCD is tested in circumstances in which there is no condensation.
- 3) The reliability test is not an out-going inspection.
- 4) The result of the reliability test is for your reference purpose only.
The reliability test is conducted only to examine the LCD's capability.

| No | Description | Drawn | Checked | Checked | Approved |
|----|-------------|-------|---------|---------|----------|
| | | | | | |
| | | | | | |

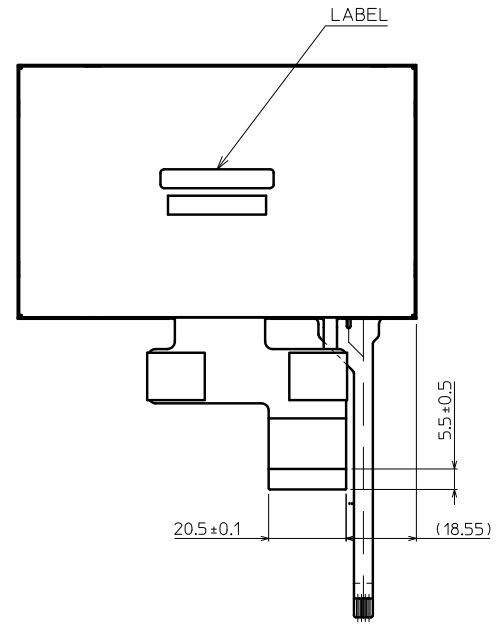
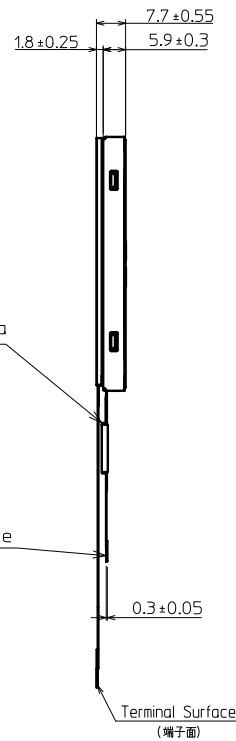
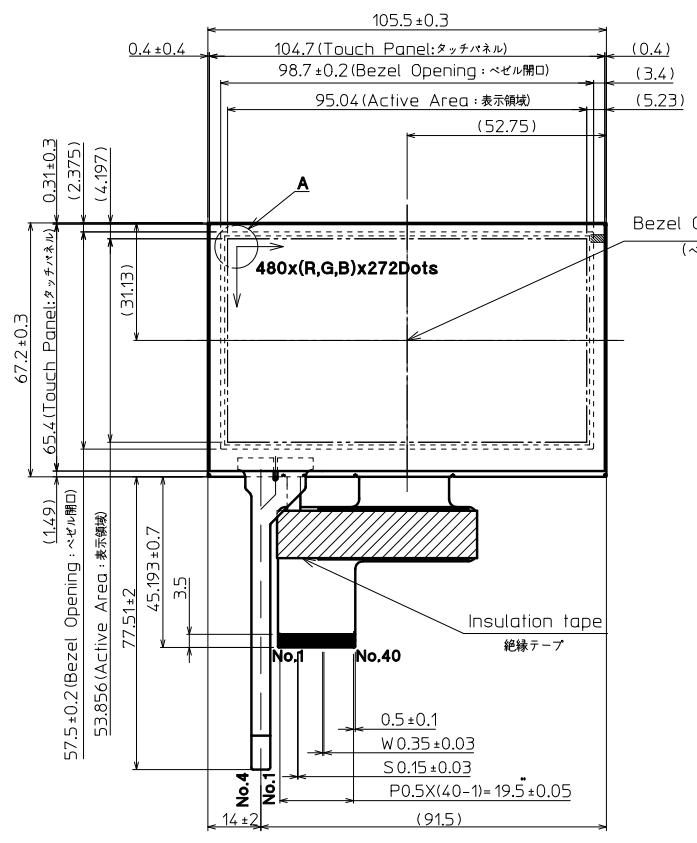

DETAIL A (Dot Size)
(NTS)

Projection part is 1.5mm thickness.
(厚み1.5mm)

- Note.(注記)
1. Matching Connector (Reference): 08 6212 040 340 800+ (KYOCERA Connector Products) etc.
(適合コネクタ(参考))
 2. Tolerance without indication : ±0.5
(指示無き公差)
 3. The Information of LCD is displayed starting at the upper left hand corner , moving right then down to the lower right hand corner.
(LCDにおいて、画像データの表示は左上コーナーから始まり、右へ進み下へ送られ右下コーナーへ向かう)
 4. Touch Panel P/N : P2012200 (121A8050000)

| | | | | | | | | | | |
|-----------------|-------------------|-----------------------|---------|----------------------|-------------------|-------------------|-------------------------|----------------------------|-----------------------------|-----------|
| Material 材質 | Treatment 処理 | Approved '12.08.02 | Checked | Checked '12.08.02 | Drawn Rahadian | Scale 1:1(NTS) | Title TCG043WQLBAAFA | | Year-Month-Day '12.07.28 | Size 2 |
| Quantity 製作数 | Description 備考 | 朝倉 | | 今村 | | | Outline Dimensions | Drawing No. 121A8061500 | | |

| | |
|----------|-----------------------|
| Spec No. | TQ3C-8EAF0-E2DFF43-00 |
| Date | August 23, 2012 |

KYOCERA INSPECTION STANDARD

TYPE : TCG043WQLBAAFA-GA50

KYOCERA CORPORATION
LCD DIVISION

| Original Issue Date | Designed by : Engineering dept. | | | Confirmed by : QA dept. | |
|---------------------|---------------------------------|---------------------|--------------------|-------------------------|----------------|
| | Prepared | Checked | Approved | Checked | Approved |
| August 23, 2012 | <i>K. Mori</i> | <i>Y. Yamaguchi</i> | <i>M. Fujitani</i> | <i>I. Hamada</i> | <i>H. Itoh</i> |

Spec No.
TQ3C-8EAF0-E2DFF43-00

Part No.
TCG043WQLBAAFA-GA50

Page
-

Revision record

| Date | | Designed by : Engineering dept. | | | Confirmed by : QA dept. | |
|---------|------|---------------------------------|--------------|----------|-------------------------|----------|
| | | Prepared | Checked | Approved | Checked | Approved |
| | | | | | | |
| Rev.No. | Date | Page | Descriptions | | | |
| | | | | | | |

Visuals specification

1) Note

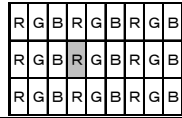
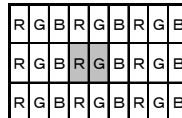
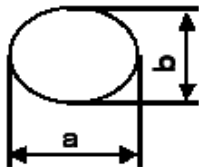
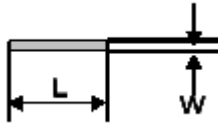
| | Note | |
|-------------------------------|---|--|
| General | <p>1. Customer identified anomalies not defined within this inspection standard shall be reviewed by Kyocera, and an additional standard shall be determined by mutual consent.</p> <p>2. This inspection standard about the image quality shall be applied to any defect within the active area and shall not be applicable to outside of the area.</p> <p>3. Inspection conditions</p> <p>Luminance : 500 Lux min.</p> <p>Inspection distance : 300 mm.</p> <p>Temperature : 25 ± 5</p> <p>Direction : Directly above</p> | |
| Definition of inspection item | Dot defect | <p>Bright dot defect</p> <p>The dot is constantly “on” when power applied to the LCD, even when all “Black” data sent to the screen. Inspection tool: 5% Transparency neutral density filter. Count dot: If the dot is visible through the filter. Don't count dot: If the dot is not visible through the filter.</p>  |
| | | <p>Black dot defect</p> <p>The dot is constantly “off” when power applied to the LCD, even when all “White” data sent to the screen.</p> |
| | | <p>Adjacent dot</p> <p>Adjacent dot defect is defined as two or more bright dot defects or black dot defects.</p>  |
| | External inspection | <p>Bubble, Scratch, Foreign particle (Polarizer, Cell, Backlight)</p> <p>Visible operating (all pixels “Black” or “White”) and non operating.</p> |
| | Appearance inspection | Does not satisfy the value at the spec. |
| Definition of size | <p>Definition of circle size</p>  <p>$d = (a + b) / 2$</p> | <p>Definition of linear size</p>  |

2) Standard

| Classification | | Inspection item | Judgement standard | | | | | | | | | | | | | | | | | | | | | | | | | | |
|--|--|--|--|-------------------------------|-------------------|-------------------|-------------------|-------------------|-------------------|-------------|-------------|---------|-------------|-------------|---------|---------|---------|-------------|-------------|---------|---|---------|---------|---|---------|--|---|--|-------------------------------|
| Defect (in LCD glass) | Dot defect | Bright dot defect | Acceptable number : 4 Bright dot spacing : 5 mm or more | | | | | | | | | | | | | | | | | | | | | | | | | | |
| | | Black dot defect | Acceptable number : 5 Black dot spacing : 5 mm or more | | | | | | | | | | | | | | | | | | | | | | | | | | |
| | | 2 dot join | Bright dot defect | Acceptable number : 2 | | | | | | | | | | | | | | | | | | | | | | | | | |
| | | | Black dot defect | Acceptable number : 3 | | | | | | | | | | | | | | | | | | | | | | | | | |
| | | 3 or more dots join | Acceptable number : 0 | | | | | | | | | | | | | | | | | | | | | | | | | | |
| | | Total dot defects | Acceptable number : 5 Max | | | | | | | | | | | | | | | | | | | | | | | | | | |
| | Others | White dot, Dark dot (Circle) | <table border="1"> <thead> <tr> <th colspan="2">Size (mm)</th> <th>Acceptable number</th> </tr> </thead> <tbody> <tr> <td>d</td> <td>0.2</td> <td>(Neglected)</td> </tr> <tr> <td>0.2 < d</td> <td>0.4</td> <td>5</td> </tr> <tr> <td>0.4 < d</td> <td>0.5</td> <td>3</td> </tr> <tr> <td>0.5 < d</td> <td></td> <td>0</td> </tr> </tbody> </table> | | | Size (mm) | | Acceptable number | d | 0.2 | (Neglected) | 0.2 < d | 0.4 | 5 | 0.4 < d | 0.5 | 3 | 0.5 < d | | 0 | | | | | | | | | |
| Size (mm) | | Acceptable number | | | | | | | | | | | | | | | | | | | | | | | | | | | |
| d | 0.2 | (Neglected) | | | | | | | | | | | | | | | | | | | | | | | | | | | |
| 0.2 < d | 0.4 | 5 | | | | | | | | | | | | | | | | | | | | | | | | | | | |
| 0.4 < d | 0.5 | 3 | | | | | | | | | | | | | | | | | | | | | | | | | | | |
| 0.5 < d | | 0 | | | | | | | | | | | | | | | | | | | | | | | | | | | |
| External inspection (Defect on Polarizer or between Polarizer and LCD glass) | Polarizer (Scratch) | <table border="1"> <thead> <tr> <th colspan="2">Width (mm)</th> <th colspan="2">Length (mm)</th> <th>Acceptable number</th> </tr> </thead> <tbody> <tr> <td>W</td> <td>0.1</td> <td colspan="2">-</td> <td>(Neglected)</td> </tr> <tr> <td rowspan="2">0.1 < W</td> <td rowspan="2">0.3</td> <td colspan="2">L 5.0</td> <td>(Neglected)</td> </tr> <tr> <td colspan="2">5.0 < L</td> <td>0</td> </tr> <tr> <td colspan="2">0.3 < W</td> <td colspan="2">-</td> <td>0</td> </tr> </tbody> </table> | | | Width (mm) | | Length (mm) | | Acceptable number | W | 0.1 | - | | (Neglected) | 0.1 < W | 0.3 | L 5.0 | | (Neglected) | 5.0 < L | | 0 | 0.3 < W | | - | | 0 | | |
| | | Width (mm) | | Length (mm) | | Acceptable number | | | | | | | | | | | | | | | | | | | | | | | |
| | | W | 0.1 | - | | (Neglected) | | | | | | | | | | | | | | | | | | | | | | | |
| | | 0.1 < W | 0.3 | L 5.0 | | (Neglected) | | | | | | | | | | | | | | | | | | | | | | | |
| | 5.0 < L | | | 0 | | | | | | | | | | | | | | | | | | | | | | | | | |
| | 0.3 < W | | - | | 0 | | | | | | | | | | | | | | | | | | | | | | | | |
| | Polarizer (Bubble) | <table border="1"> <thead> <tr> <th colspan="2">Size (mm)</th> <th>Acceptable number</th> </tr> </thead> <tbody> <tr> <td>d</td> <td>0.2</td> <td>(Neglected)</td> </tr> <tr> <td>0.2 < d</td> <td>0.3</td> <td>5</td> </tr> <tr> <td>0.3 < d</td> <td>0.5</td> <td>3</td> </tr> <tr> <td>0.5 < d</td> <td></td> <td>0</td> </tr> </tbody> </table> | | | Size (mm) | | Acceptable number | d | 0.2 | (Neglected) | 0.2 < d | 0.3 | 5 | 0.3 < d | 0.5 | 3 | 0.5 < d | | 0 | | | | | | | | | | |
| | | Size (mm) | | Acceptable number | | | | | | | | | | | | | | | | | | | | | | | | | |
| | | d | 0.2 | (Neglected) | | | | | | | | | | | | | | | | | | | | | | | | | |
| | | 0.2 < d | 0.3 | 5 | | | | | | | | | | | | | | | | | | | | | | | | | |
| 0.3 < d | 0.5 | 3 | | | | | | | | | | | | | | | | | | | | | | | | | | | |
| 0.5 < d | | 0 | | | | | | | | | | | | | | | | | | | | | | | | | | | |
| Foreign particle (Circular shape) | <table border="1"> <thead> <tr> <th colspan="2">Size (mm)</th> <th>Acceptable number</th> </tr> </thead> <tbody> <tr> <td>d</td> <td>0.2</td> <td>(Neglected)</td> </tr> <tr> <td>0.2 < d</td> <td>0.4</td> <td>5</td> </tr> <tr> <td>0.4 < d</td> <td>0.5</td> <td>3</td> </tr> <tr> <td>0.5 < d</td> <td></td> <td>0</td> </tr> </tbody> </table> | | | Size (mm) | | Acceptable number | d | 0.2 | (Neglected) | 0.2 < d | 0.4 | 5 | 0.4 < d | 0.5 | 3 | 0.5 < d | | 0 | | | | | | | | | | | |
| | Size (mm) | | Acceptable number | | | | | | | | | | | | | | | | | | | | | | | | | | |
| | d | 0.2 | (Neglected) | | | | | | | | | | | | | | | | | | | | | | | | | | |
| | 0.2 < d | 0.4 | 5 | | | | | | | | | | | | | | | | | | | | | | | | | | |
| 0.4 < d | 0.5 | 3 | | | | | | | | | | | | | | | | | | | | | | | | | | | |
| 0.5 < d | | 0 | | | | | | | | | | | | | | | | | | | | | | | | | | | |
| Foreign particle (Linear shape) Scratch | <table border="1"> <thead> <tr> <th colspan="2">Width (mm)</th> <th colspan="2">Length (mm)</th> <th>Acceptable number</th> </tr> </thead> <tbody> <tr> <td>W</td> <td>0.03</td> <td colspan="2">-</td> <td>(Neglected)</td> </tr> <tr> <td rowspan="3">0.03 < W</td> <td rowspan="3">0.1</td> <td colspan="2">L 2.0</td> <td>(Neglected)</td> </tr> <tr> <td colspan="2">2.0 < L 4.0</td> <td>3</td> </tr> <tr> <td colspan="2">4.0 < L</td> <td>0</td> </tr> <tr> <td colspan="2">0.1 < W</td> <td colspan="2">-</td> <td>(According to circular shape)</td> </tr> </tbody> </table> | | | Width (mm) | | Length (mm) | | Acceptable number | W | 0.03 | - | | (Neglected) | 0.03 < W | 0.1 | L 2.0 | | (Neglected) | 2.0 < L 4.0 | | 3 | 4.0 < L | | 0 | 0.1 < W | | - | | (According to circular shape) |
| | Width (mm) | | Length (mm) | | Acceptable number | | | | | | | | | | | | | | | | | | | | | | | | |
| | W | 0.03 | - | | (Neglected) | | | | | | | | | | | | | | | | | | | | | | | | |
| | 0.03 < W | 0.1 | L 2.0 | | (Neglected) | | | | | | | | | | | | | | | | | | | | | | | | |
| | | | 2.0 < L 4.0 | | 3 | | | | | | | | | | | | | | | | | | | | | | | | |
| 4.0 < L | | | 0 | | | | | | | | | | | | | | | | | | | | | | | | | | |
| 0.1 < W | | - | | (According to circular shape) | | | | | | | | | | | | | | | | | | | | | | | | | |

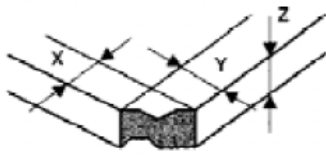
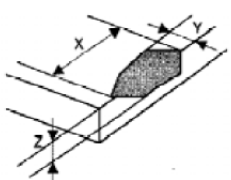
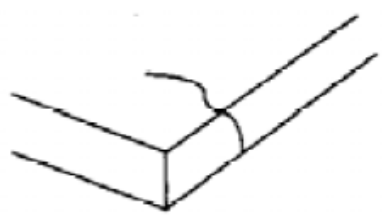
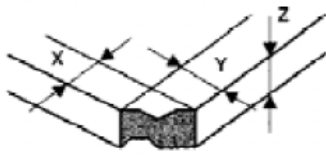
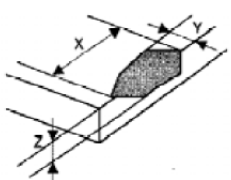
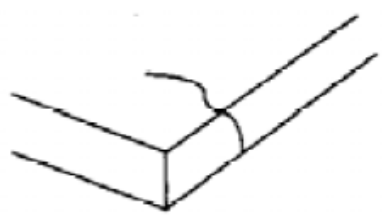
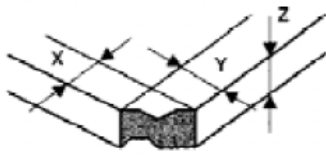
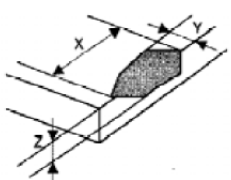
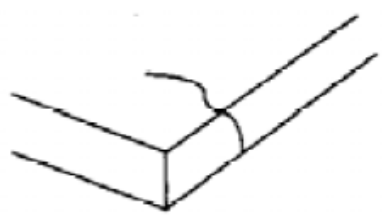
| Inspection item | Judgement standard | | | | | | | | | | | | | | | | | | | | | | | | | | | | | | | |
|---|--|---|-------------------|-------------------|-------------------|---|--------|------|-----------|---|---|-------------------|---------------|-------|----------------------|--|-------------------------|-------------------|--------------------------|--------|-----------|-----------|--------------|-----|------------------|----------------------------|-------|--|-----------|-------------|--|------------------|
| Scratch, Foreign particle (Touch screen portion) | (W = Width, L = Length, D = Diameter = (major axis + minor axis)/ 2) | | | | | | | | | | | | | | | | | | | | | | | | | | | | | | | |
| | <table border="1"> <thead> <tr> <th>Item</th> <th>Width(mm)</th> <th>Length(mm)</th> <th>Acceptable number</th> </tr> </thead> <tbody> <tr> <td rowspan="4">Scratch</td> <td>d 0.03</td> <td>L 20</td> <td>Neglected</td> </tr> <tr> <td>0.03 < d 0.05</td> <td>L 10</td> <td>2pcs within φ20mm</td> </tr> <tr> <td>0.05 < d 0.08</td> <td>L 6</td> <td>2pcs within φ20mm</td> </tr> <tr> <td>0.08 < d 0.1</td> <td>L 4</td> <td>1pcs within φ30mm</td> </tr> <tr> <td rowspan="2">Foreign (line like)</td> <td>W 0.05</td> <td>Neglected</td> <td>Neglected</td> </tr> <tr> <td>0.05 < W 0.1</td> <td>L 5</td> <td>2pcs within 30mm</td> </tr> <tr> <td rowspan="2">Foreign (circle like)</td> <td>D 0.2</td> <td></td> <td>Neglected</td> </tr> <tr> <td>0.2 < D 0.3</td> <td></td> <td>2pcs within 30mm</td> </tr> </tbody> </table> | Item | Width(mm) | Length(mm) | Acceptable number | Scratch | d 0.03 | L 20 | Neglected | 0.03 < d 0.05 | L 10 | 2pcs within φ20mm | 0.05 < d 0.08 | L 6 | 2pcs within φ20mm | 0.08 < d 0.1 | L 4 | 1pcs within φ30mm | Foreign (line like) | W 0.05 | Neglected | Neglected | 0.05 < W 0.1 | L 5 | 2pcs within 30mm | Foreign (circle like) | D 0.2 | | Neglected | 0.2 < D 0.3 | | 2pcs within 30mm |
| | Item | Width(mm) | Length(mm) | Acceptable number | | | | | | | | | | | | | | | | | | | | | | | | | | | | |
| | Scratch | d 0.03 | L 20 | Neglected | | | | | | | | | | | | | | | | | | | | | | | | | | | | |
| | | 0.03 < d 0.05 | L 10 | 2pcs within φ20mm | | | | | | | | | | | | | | | | | | | | | | | | | | | | |
| | | 0.05 < d 0.08 | L 6 | 2pcs within φ20mm | | | | | | | | | | | | | | | | | | | | | | | | | | | | |
| | | 0.08 < d 0.1 | L 4 | 1pcs within φ30mm | | | | | | | | | | | | | | | | | | | | | | | | | | | | |
| | Foreign (line like) | W 0.05 | Neglected | Neglected | | | | | | | | | | | | | | | | | | | | | | | | | | | | |
| | | 0.05 < W 0.1 | L 5 | 2pcs within 30mm | | | | | | | | | | | | | | | | | | | | | | | | | | | | |
| | Foreign (circle like) | D 0.2 | | Neglected | | | | | | | | | | | | | | | | | | | | | | | | | | | | |
| 0.2 < D 0.3 | | | 2pcs within 30mm | | | | | | | | | | | | | | | | | | | | | | | | | | | | | |
| Above are applied to the visible area. | | | | | | | | | | | | | | | | | | | | | | | | | | | | | | | | |
| Unless there are foreign particle and damage affected seriously to the electrical performance out of the active area, we approve of this product. | | | | | | | | | | | | | | | | | | | | | | | | | | | | | | | | |
| Glass crack (Touch screen portion) | <table border="1"> <thead> <tr> <th>Item</th> <th>Size (mm)</th> <th>Acceptable number</th> </tr> </thead> <tbody> <tr> <td rowspan="3">Corner crack</td> <td rowspan="3">  </td> <td>X 3</td> </tr> <tr> <td>Y 3</td> </tr> <tr> <td>Z < t</td> </tr> <tr> <td rowspan="3">Crack in other area than in corner</td> <td rowspan="3">  </td> <td>X 5</td> </tr> <tr> <td>Y 1.5</td> </tr> <tr> <td>Z < t</td> </tr> <tr> <td>Progressive crack</td> <td>  </td> <td>0 pcs (NG even 1pcs)</td> </tr> </tbody> </table> | Item | Size (mm) | Acceptable number | Corner crack |  | X 3 | Y 3 | Z < t | Crack in other area than in corner |  | X 5 | Y 1.5 | Z < t | Progressive crack |  | 0 pcs (NG even 1pcs) | | | | | | | | | | | | | | | |
| | Item | Size (mm) | Acceptable number | | | | | | | | | | | | | | | | | | | | | | | | | | | | | |
| | Corner crack |  | X 3 | | | | | | | | | | | | | | | | | | | | | | | | | | | | | |
| | | | Y 3 | | | | | | | | | | | | | | | | | | | | | | | | | | | | | |
| Z < t | | | | | | | | | | | | | | | | | | | | | | | | | | | | | | | | |
| Crack in other area than in corner |  | X 5 | | | | | | | | | | | | | | | | | | | | | | | | | | | | | | |
| | | Y 1.5 | | | | | | | | | | | | | | | | | | | | | | | | | | | | | | |
| | | Z < t | | | | | | | | | | | | | | | | | | | | | | | | | | | | | | |
| Progressive crack |  | 0 pcs (NG even 1pcs) | | | | | | | | | | | | | | | | | | | | | | | | | | | | | | |